



Driver LC 13/15W 300/350mA fixC SR SNC

ESSENCE series

Product description

- Independent driver with strain-relief housing
- Extra flat housing for constrained installation conditions (small ceiling cut outs and low ceiling voids)
- Max. output power 13 or 15 W
- Output current 300 or 350 mA
- KC certificate for LC 15W 350mA fixC SR SNC
- For luminaires with M and MM as per EN 60598, VDE 0710 and VDE 0711
- Nominal life-time up to 50,000 h
- Temperature protection as per EN 61347-2-13 C5e
- 5-year guarantee



Properties

- Casing: polycarbonat, white
- Type of protection IP20
- Push-in terminals
- 2 separate strain relief parts for input and output cables with highly robust clamps

Functions

- Overload protection
- Short-circuit protection
- No-load protection
- No output current overshoot at mains on/off



Standards, page 3

Wiring diagrams and installation examples, page 4

IP20 SELV                            

Driver LC 13/15W 300/350mA fixC SR SNC

ESSENCE series

Technical data

Rated supply voltage	220 – 240 V
AC voltage range	198 – 264 V
λ at full load ^①	0.90C
λ at min. load ^①	0.86C
Mains frequency	50/60 Hz
Overvoltage protection	320 V AC, 1 h
THD (at 230 V, 50 Hz, full load)	≤ 20 %
THD (at 230 V, 50 Hz, min. load)	≤ 20 %
Output current tolerance (at 230 V, 50 Hz, full load) ^②	± 7.5 %
Output current tolerance (at 230 V, 50 Hz, min. load) ^②	± 7.5 %
Typ. output LF current ripple at full load	± 30 %
Turn on time (at 230 V, 50 Hz, full load)	≤ 0.5 s
Turn off time (at 230 V, 50 Hz, full load)	≤ 0.5 s
Hold on time at power failure	0 s
Ambient temperature t_a	-25 ... +50 °C
Ambient temperature t_a (at life-time 50,000 h)	40 °C
Storage temperature t_s	-40 ... +80 °C
Dimensions L x W x H	101.5 x 51 x 22 mm

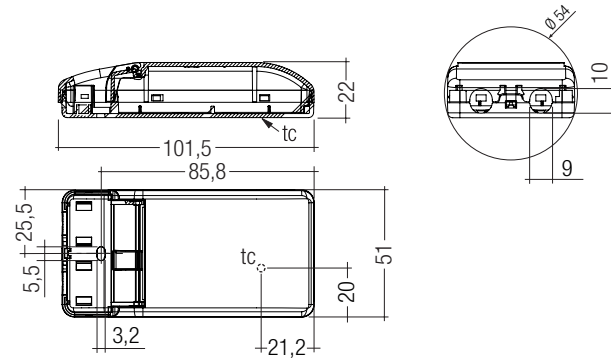

Ordering data

Type	Article number	Packaging carton	Packaging, low volume	Packaging, high volume	Weight per pc.
LC 13W 300mA fixC SR SNC	87500571	20 pc(s).	380 pc(s).	3,420 pc(s).	0.068 kg
LC 15W 350mA fixC SR SNC	87500572	20 pc(s).	380 pc(s).	3,420 pc(s).	0.068 kg

Specific technical data

Type	Output current ^② (at 230 V, 50 Hz, full load)	Typ. rated current (at 230 V, 50 Hz, full load)	Max. input power	Typ. power consumption (at 230 V, 50 Hz, full load)	Output power	Efficiency at full load ^③	Efficiency at min. load ^③	Min. forward voltage ^③	Max. forward voltage ^③	Max. output voltage	Max. peak output current	Max. casing temperature t_c
LC 13W 300mA fixC SR SNC	300 mA	0.08 A	16 W	15 W	9 – 13 W	83 %	82 %	30 V	43 V	55 V	500 mA	85 °C
LC 15W 350mA fixC SR SNC	350 mA	0.09 A	19 W	17 W	10 – 15 W	85 %	83 %	30 V	43 V	55 V	600 mA	85 °C

^① Test result at 230 V, 50 Hz

^② Output current is mean value.

Standards

EN 55015
EN 61000-3-2
EN 61000-3-3
EN 61347-1
EN 61347-2-13
EN 61547
EN 62384

Overload protection

If the output voltage range is exceeded the LED Driver will protect itself. After elimination of the overload the nominal operation is restored automatically.

Short-circuit behaviour

In case of a short circuit on the secondary side (LED) the LED control gear switches into hic-cup mode. After the removal of the short-circuit fault the LED control gear will recover automatically.

No-load operation

The LED Driver works in burst working mode to provide a constant output voltage regulation which allows the application to be able to work safely when LED string open due a failure.

In no-load operation the output voltage will not exceed the specified max. output voltage (see page 2).

Conditions of use and storage

Humidity: 5 % up to max. 85 %,
not condensed
(max. 56 days/year at 85 %)

Storage temperature: -40 °C up to max. +80 °C

The devices have to be within the specified temperature range (ta) before they can be operated.

Glow wire test

according to EN 60598-1 with increased temperature of 850 °C passed.

Expected life-time

Type	ta	40 °C	50 °C	
LC 13W 300mA fixC SR SNC	tc	75 °C	85 °C	x
	Life-time	50,000 h	30,000 h	x
LC 15W 350mA fixC SR SNC	tc	75 °C	85 °C	x
	Life-time	50,000 h	30,000 h	x

The LED Drivers are designed for a life-time stated above under reference conditions and with a failure probability of less than 10 %.

Life-time declarations are informative and represent no warranty claim.

Maximum loading of automatic circuit breakers

Automatic circuit breaker type									Inrush current	
	C10	C13	C16	C20	B10	B13	B16	B20	I _{max}	Time
Installation Ø	1.5 mm ²	1.5 mm ²	1.5 mm ²	2.5 mm ²	1.5 mm ²	1.5 mm ²	1.5 mm ²	2.5 mm ²		
LC 13W 300mA fixC SR SNC	110	145	180	220	90	115	145	175	8 A	80 µs
LC 15W 350mA fixC SR SNC	105	135	165	205	90	115	145	175	8 A	80 µs

Harmonic distortion in the mains supply (at 230 V / 50 Hz and full load) in %

	THD	3.	5.	7.	9.	11.
LC 13W 300mA fixC SR SNC	< 20	< 16	< 7	< 4	< 3	< 3
LC 15W 350mA fixC SR SNC	< 20	< 16	< 7	< 4	< 3	< 3

Installation instructions

The LED module and all contact points within the wiring must be sufficiently insulated against 3.5 kV surge voltage.

Air and creepage distance must be maintained.

Replace LED module

1. Mains off
2. Remove LED module
3. Wait for 10 seconds
4. Connect LED module again

Hot plug-in or secondary switching of LEDs is not permitted and may cause a very high current to the LEDs.

Wiring type and cross section

The wiring can be in stranded wires with ferrules or solid. For perfect function of the cage clamp terminals the strip length should be 9 – 10 mm for the input terminal.

The max. torque at the clamping screw (M3) is 0.2 Nm.

Use one wire for each terminal connector only.

Use each strain relief channel for one cable only.

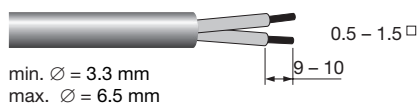

The following cable types are approved and recommended by Tridonic:

- RVVB 2x0.5 mm²
- H03VVH2-F2G0.75
- RVVB 2x1.0 mm²
- RVV 2x1.5 mm²

Wiring guidelines

- All connections must be kept as short as possible to ensure good EMI behaviour.
- Mains leads should be kept apart from LED Driver and other leads (ideally 5 – 10 cm distance)
- Max. length of output wires is 2 m.
- Secondary switching is not permitted.
- Incorrect wiring can damage LED modules.
- To avoid the damage of the Driver, the wiring must be protected against short circuits to earth (sharp edged metal parts, metal cable clips, louver, etc.).

Additional information

Additional technical information at www.tridonic.com → Technical Data

Guarantee conditions at www.tridonic.com → Services

No warranty if device was opened.

Fixing conditions

Dry, acidfree, oilfree, fatfree. It is not allowed to exceed the maximum ambient temperature (t_a) stated on the device. Minimum distances stated below are recommendations and depend on the actual luminaire.

Is not suitable for fixing in corner.

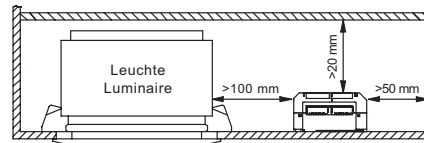
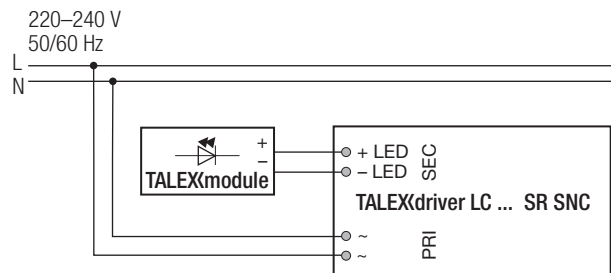
**Wiring diagram****Isolation and electric strength testing of luminaires**

Electronic devices can be damaged by high voltage. This has to be considered during the routine testing of the luminaires in production.

According to IEC 60598-1 Annex Q (informative only!) or ENEC 303-Annex A, each luminaire should be submitted to an isolation test with 500 V_{DC} for 1 second. This test voltage should be connected between the interconnected phase and neutral terminals and the earth terminal.

The isolation resistance must be at least 2 M Ω .

As an alternative, IEC 60598-1 Annex Q describes a test of the electrical strength with 1500 V_{AC} (or 1.414 x 1500 V_{DC}). To avoid damage to the electronic devices this test must not be conducted.

Diagrams LC 13W 300mA fixC SR SNC

Efficiency vs load

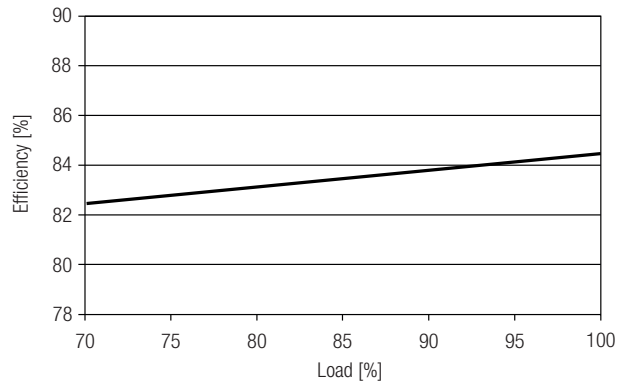

Power factor vs load

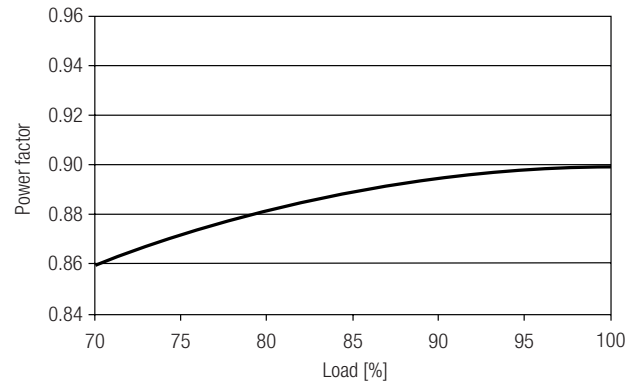

THD vs load

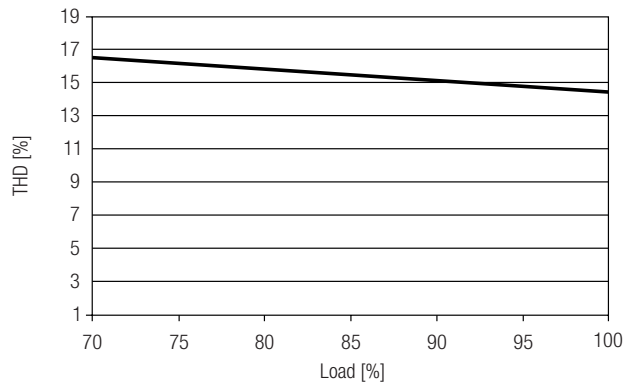

Input current vs load

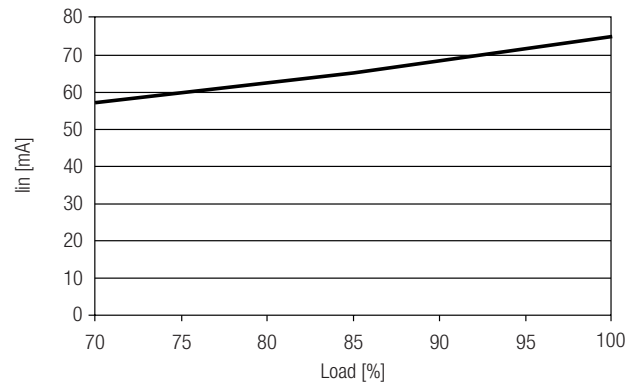

Input power vs load

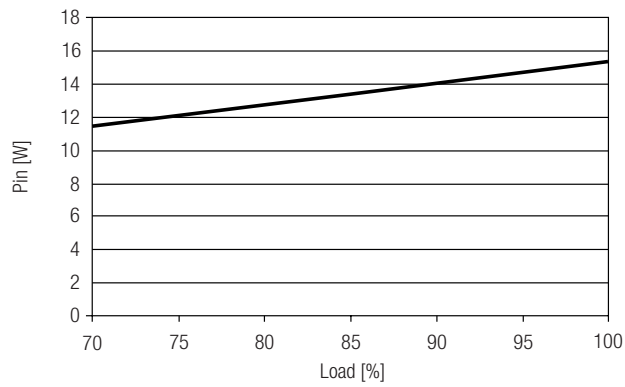

Diagrams LC 15W 350mA fixC SR SNC

Efficiency vs load

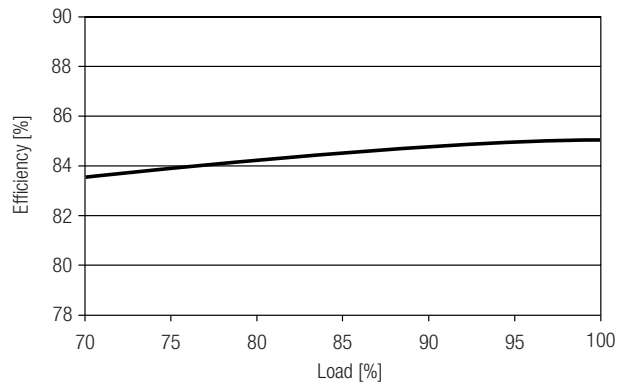

Power factor vs load

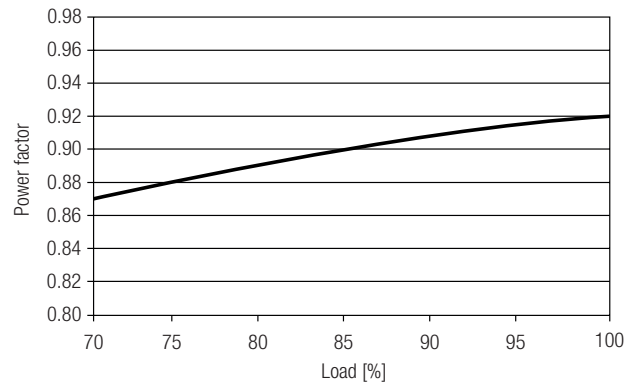

THD vs load

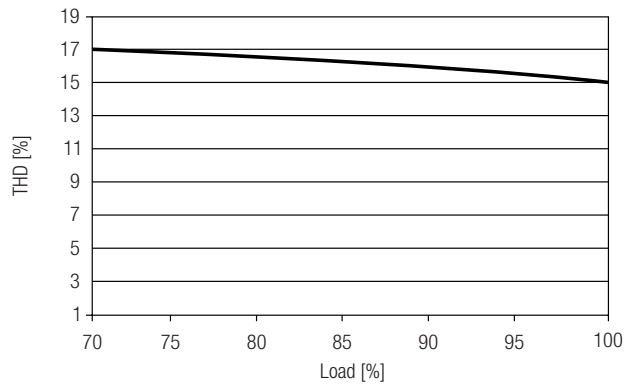

Input current vs load

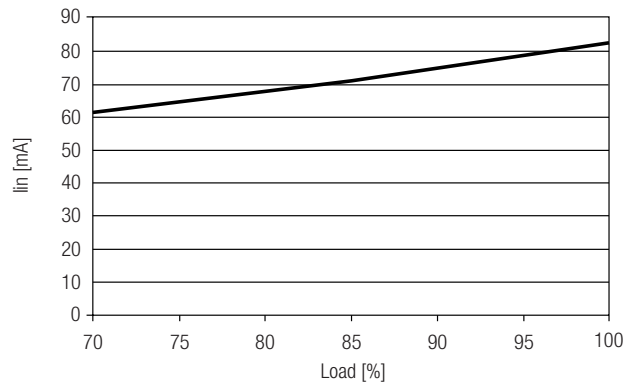

Input power vs load

