

LED Driver

# **LCA PRE, LC EXC**

Manual



**TRIDONIC**

# Table of contents

|                                                               |           |
|---------------------------------------------------------------|-----------|
| <b>1. Validity</b>                                            | <b>4</b>  |
| 1.1. Copyright                                                | 4         |
| 1.2. Imprint                                                  | 4         |
| <b>2. General safety instructions</b>                         | <b>5</b>  |
| 2.1. Intended use                                             | 5         |
| 2.2. Dangers associated with the operation of the system      | 5         |
| 2.3. Environment                                              | 5         |
| 2.4. Additional instructions                                  | 6         |
| <b>3. Description and key features</b>                        | <b>7</b>  |
| 3.1. Description of key features                              | 7         |
| 3.2. Two-part layer structure                                 | 8         |
| 3.3. Housing variants                                         | 10        |
| 3.4. Adjustable output current, voltage and power             | 11        |
| 3.5. Operating Window Multichannel                            | 14        |
| <b>4. Compatibility between LED module and LED Driver</b>     | <b>23</b> |
| 4.1. Comparison of data sheet values with a 4-point guideline | 23        |
| 4.2. Application of the 4-point guideline                     | 25        |
| 4.3. Practical tests                                          | 31        |
| <b>5. Installation notes</b>                                  | <b>32</b> |
| 5.1. Safety information                                       | 32        |
| 5.2. Function of the earth terminal                           | 33        |
| 5.3. Routing the wires                                        | 35        |
| 5.4. External fuse for DC operation                           | 36        |
| 5.5. Maximum loading of circuit breakers                      | 37        |
| <b>6. Functions</b>                                           | <b>41</b> |
| 6.1. corridorFUNCTION V2 (PRE only)                           | 41        |
| 6.2. DSI (PRE only)                                           | 46        |
| 6.3. switchDIM (PRE only)                                     | 47        |
| 6.4. Power-up Fading (PRE only)                               | 51        |
| 6.5. DALI (PRE only)                                          | 52        |
| 6.6. ready2mains                                              | 54        |
| 6.7. Constant Light Output (PRE only)                         | 55        |
| 6.8. DC recognition                                           | 57        |
| 6.9. Dimming on DC (PRE only)                                 | 58        |
| 6.10. Intelligent Temperature Guard                           | 59        |
| 6.11. colourSWITCH                                            | 61        |

## Table of contents

|                                         |           |
|-----------------------------------------|-----------|
| 6.12. proportionSWITCH (PRE only) ..... | 65        |
| 6.13. 1-10 V Interface .....            | 70        |
| <b>7. Reference list</b>                | <b>71</b> |
| 7.1. Additional information .....       | 71        |
| 7.2. Downloads .....                    | 71        |
| 7.3. Technical data .....               | 71        |

## Scope of documentation

These operating instructions are valid for LED Driver of the LCA PRE and LC EXC series. Not included are LC EXC Driver with wide voltage input range und LC OTD Driver.

If a reference is made to one of the two versions then the descriptions are valid only for that version.

The series comprises additional versions. However, the other versions ADV, SNC, ECO, TOP, TEC are not covered in detail within this documentation.

TRIDONIC GmbH & Co KG is constantly striving to develop all its products. This means that there may be changes in form, equipment and technology.

Claims cannot therefore be made on the basis of information, diagrams or descriptions in these instructions.

The latest version of these operating instructions is available on our home page at

<http://www.tridonic.com/com/en/operating-instructions.asp>

### 1.1. Copyright

This documentation may not be changed, expanded, copied or passed to third parties without the prior written agreement of TRIDONIC GmbH & Co KG.

We are always open to comments, corrections and requests. Please send them to [info@tridonic.com](mailto:info@tridonic.com)

### 1.2. Imprint

Tridonic GmbH & Co KG  
Färbergasse 15  
6851 Dornbirn  
Austria

T +43 5572 395-0

F +43 5572 20176

[www.tridonic.com](http://www.tridonic.com)

## General safety instructions

The instructions in this section have been compiled to ensure that operators and users of LED Driver LCA PRE and LC EXC from Tridonic are able to detect potential risks in good time and take the necessary preventative measures. The operator must ensure that all users fully understand these instructions and adhere to them. This device may only be installed and configured by suitably qualified personnel.

### 2.1. Intended use

#### 2.1.1. Proper use

Operation of LED light modules. The device may only be used for this intended purpose.

#### 2.1.2. Improper use

Outdoor use. Extensions and modifications to the product.

#### WARNING!

Improper use could result in injury, malfunction or damage to property.  
It must be ensured that the operator informs every user of existing hazards.

### 2.2. Dangers associated with the operation of the system

#### DANGER!

Danger of electrocution  
Disconnect the power to the entire lighting system before working on the lighting system!

### 2.3. Environment

#### DANGER!

Not to be used in corrosive or explosive environments.

#### CAUTION!

Risk of damage caused by humidity and condensation

- \_ Only use the control device in dry rooms and protect it against humidity!
- \_ Prior to commissioning the system, wait until the control device is at room temperature and completely dry!

## General safety instructions

### 2.4. Additional instructions

**⚠ CAUTION!**

Electromagnetic compatibility (EMC)

Although the device meets the stringent requirements of the appropriate directives and standards on electromagnetic compatibility, it could potentially interfere with other devices under certain circumstances!

## Description and key features

### 3.1. Description of key features

LCA PRE and LC EXC is a portfolio of LED Drivers. It has been optimised and simplified to meet the typical requirements of LED solutions.



- \_ Different requirements:  
The layers PRE and EXC offer solutions for different requirements (e.g. dimming/fixed output, lifetime, applications)
- \_ State-of-the-art dimming technology:  
Stepless dimming from 100 to 1 % (PRE) (see [Two-part layer structure](#), S. 8).
- \_ Broad range of casing shapes:  
Different casing shapes (compact, stretched compact, independent, low profile) and sizes for different built-in versions
- \_ Adjustable output current:  
Simple option for setting current and voltage values transition-free (PRE and EXC) allows the device to be used with virtually all light modules
- \_ Diversity of functions:  
Familiar and new functions, e.g. DALI, DSI, switchDIM, corridorFUNCTION, dimming (PRE only), ready2mains (PRE and EXC)
- \_ Tunable White (PRE only):  
DT8: Dimming range: 3 - 100 %, colour temperature: 2,700 - 6,500 K, colourSWITCH  
2xCH / 4xCH DT 6: Dimming range: 1 - 100 %, proportionSWITCH

## Description of key features





### 3.2. Two-part layer structure

The layers LCA PRE and LC EXC differ as follows:

#### 3.2.1. Dimming (PRE only)

| Portfolio         | PRE                                                                                                                                                                                                                                              |
|-------------------|--------------------------------------------------------------------------------------------------------------------------------------------------------------------------------------------------------------------------------------------------|
| Dimmable          |                                                                                                                                                                 |
| Dimming method    | Amplitude dimming                                                                                                                                                                                                                                |
| Dimming range     | 100 to 1 %<br>100 to 3 % at TW DT8                                                                                                                                                                                                               |
| Dimming curve     | Logarithmic dimming curve (standard)<br>Switching to linear dimming curve via masterCONFIGURATOR is possible.                                                                                                                                    |
| Dimming interface | DALI-2 DT6, DSI, ready2mains, corridorFUNCTION V2, switchDIM                                                                                                                                                                                     |
| ready2mains       | <div style="border: 1px solid #0070C0; padding: 5px;"> <p> <b>NOTICE</b></p> <p>ready2mains is not available for TW DT8 and 2xCH / 4xCH DT 6 driver.</p> </div> |

#### 3.2.2. Functions

| Portfolio                     | PRE                                                                                 | EXC                                                                                   |
|-------------------------------|-------------------------------------------------------------------------------------|---------------------------------------------------------------------------------------|
| Constant Light Output         |  |                                                                                       |
| Intelligent Temperature Guard |  |  |
| Power-up Fading               |  |                                                                                       |
| DC Operation                  | DC level adjustable<br>supporting EN 50172                                          | DC level fixed<br>supporting EN 50172                                                 |
| Constant Light Output         |  |                                                                                       |



## Description of key features

### 3.2.3. Output current

| Portfolio                 | PRE                                                                             | EXC                                                                             |
|---------------------------|---------------------------------------------------------------------------------|---------------------------------------------------------------------------------|
| Adjustable output current | ✓                                                                               | ✓                                                                               |
| Adjustable via...         | DALI-2 DT6, ready2mains, I-select 2 plug (resistor)                             | ready2mains, I-select 2 plug (resistor)                                         |
| Step size                 | 1 mA                                                                            | 1 mA                                                                            |
| Tolerance                 | Further information can be found in the data sheet (see Reference list, S. 71). | Further information can be found in the data sheet (see Reference list, S. 71). |

#### **i** NOTICE

ready2mains is not included in TW DT8 and 2xCH / 4xCH DT 6.

#### **i** NOTICE

Tunable White has device type DALI DT 8

#### **i** NOTICE

By using I-Select Plugs, all channels on the TW DT8 and 2xCH / 4xCH DT 6 will be set to the same current.





### 3.2.4. Technical data

| Portfolio            | PRE       | EXC       |
|----------------------|-----------|-----------|
| Rated supply voltage | 220-240 V | 220-240 V |
| Standby losses       | < 0.2 W   |           |

## Description of key features

### 3.3. Housing variants

All the layers are available in three different housing variants: compact, independent and low profile.

| Image                                                                                                                                                                                                                                                                            | Description                                                                                                                                                                                                                                                                                                                            |
|----------------------------------------------------------------------------------------------------------------------------------------------------------------------------------------------------------------------------------------------------------------------------------|----------------------------------------------------------------------------------------------------------------------------------------------------------------------------------------------------------------------------------------------------------------------------------------------------------------------------------------|
|  <p>A compact, rectangular white housing variant with a terminal block on the front and a strain relief on the side.</p>                                                                        | <p>Housing variant compact</p> <ul style="list-style-type: none"> <li>_ Compact shape for installation inside the luminaire casing (in-built)</li> <li>_ Typical area of application: Spotlights, downlights</li> </ul>                                                                                                                |
|  <p>Two stretched compact housing variants. The top one is a long, thin white housing with a strain relief. The bottom one is a similar housing with a strain relief and a terminal block.</p> | <p>Housing variant stretched compact</p> <ul style="list-style-type: none"> <li>_ Shape that can be used as compact or independent (for an installation outside the luminaire strain relief can be attached to the casing)</li> <li>_ Typical area of application: Spotlight, downlight</li> </ul>                                     |
|  <p>An independent housing variant, which is a long, rectangular white housing with four terminal ports on the front.</p>                                                                     | <p>Housing variant independent</p> <ul style="list-style-type: none"> <li>_ Long and small shape for installation outside the luminaire casing (remote)</li> <li>_ Typical area of application: Spotlights, Downlights</li> <li>_ Special characteristic: Full loop-through capability of mains and interface (DALI) cables</li> </ul> |
|  <p>A low profile housing variant, which is a long, thin white housing with a terminal block on the front.</p>                                                                                | <p>Housing variant low profile</p> <ul style="list-style-type: none"> <li>_ Flat shape for a space-saving installation inside the luminaire casing (in-built)</li> <li>_ Typical area of application: area lighting, linear lighting</li> </ul>                                                                                        |

## Description of key features

### 3.4. Adjustable output current, voltage and power

LCA PRE and LC EXC allow for different combinations of power and current based on the standard lumen packages available on the market.

#### 3.4.1. Adjusting the Output current

| Layer            | Output current adjustable via...                                  |
|------------------|-------------------------------------------------------------------|
| PRE              | DALI / masterCONFIGURATOR, ready2mains, I-select 2 plug, resistor |
| EXC              | ready2mains, I-select 2 plug, resistor                            |
| TW DT8           | DALI / masterCONFIGURATOR, I-select 2 Plug, resistor              |
| 2xCH / 4xCH DT 6 | DALI / masterCONFIGURATOR, I-select 2 Plug, resistor              |

#### Adjusting the output current via DALI or ready2mains

Further information about DALI (see [DALI](#), S. 52) or ready2mains (see [ready2mains](#), S. ) can be found in the corresponding function description.

#### Adjusting of the output current via I-select 2 plug

By inserting a suitable resistor into the I-select 2 interface, the current value can be adjusted.

The most important data of the I-select 2 plug looks as follows:

- \_ Ready-for-use resistor to set output current value
- \_ Compatible with LED Driver featuring I-select 2 interface; not compatible with I-select (generation 1)
- \_ Resistor is base isolated
- \_ Resistor power 0.25 W
- \_ Current tolerance  $\pm 2\%$  to nominal current value
- \_ Compatible with LED Driver series PRE and EXC
- \_ For TW DT8 and 2xCH / 4xCH DT 6 devices, the I-SELECT setting is applied to all channels

If the resistor is connected by wires a consistent base isolation must be ensured. Furthermore, a max. wire length of 2 m must not be exceeded. Potential interferences have to be avoided because they can cause additional tolerance to the output current. To ensure no influence of interferences on the resistor value use shielded wires to connect the I-select 2 plug. GND of shielded wire must be connected to the corresponding I-select 2 plug terminal marked with GND in the data sheet.

LED modules with on-board I-select 2 resistors may cause irreparable damages, caused by surge / burst peaks.

## Description of key features

### **i** NOTICE

Please note that the resistor values for I-select 2 are not compatible with I-select (generation 1). Installation of an incorrect resistor may cause irreparable damage to the LED module(s).

Resistors for the main output current values can be ordered from Tridonic. Further information about accessories can be found on the TRIDONIC homepage and in the respective data sheet (see [Reference list](#), S. 71).

### Adjusting the output current via resistor

The output current of the LED Driver gear can be changed by setting different resistances. The resistance values are taken from the E96 series.

Unlike DALI and ready2mains which do not generate additional tolerances in the output current, tolerances are higher when using I-select 2 plugs.

The relationship between output current and resistor value looks as follows:

- \_  $R [k] = 5 V / I_{out} [mA] \times 1,000$
- \_ Resistor value tolerance 1 %; resistor power 0.1 W; base isolation necessary

### **i** NOTICE

The output current tolerance depends on the tolerance of the resistors.

### 3.4.2. Output voltage

The output voltage range results from the current selected. For more information see the data sheet (see [Reference list](#), S. 71).

The output current can be adjusted via DALI, ready2mains or an I-Select 2 resistor. The diagrams below show the forward voltage ranges as a function of the output current and are intended as a guide. For detailed values and an explanation of the methods available please refer to the data sheets.

ready2mains is not supported on our tunable white DT 8 and 2xCH / 4xCH DT 6 devices.

## Description of key features

### Operating window 100-400 mA I<sub>p</sub>

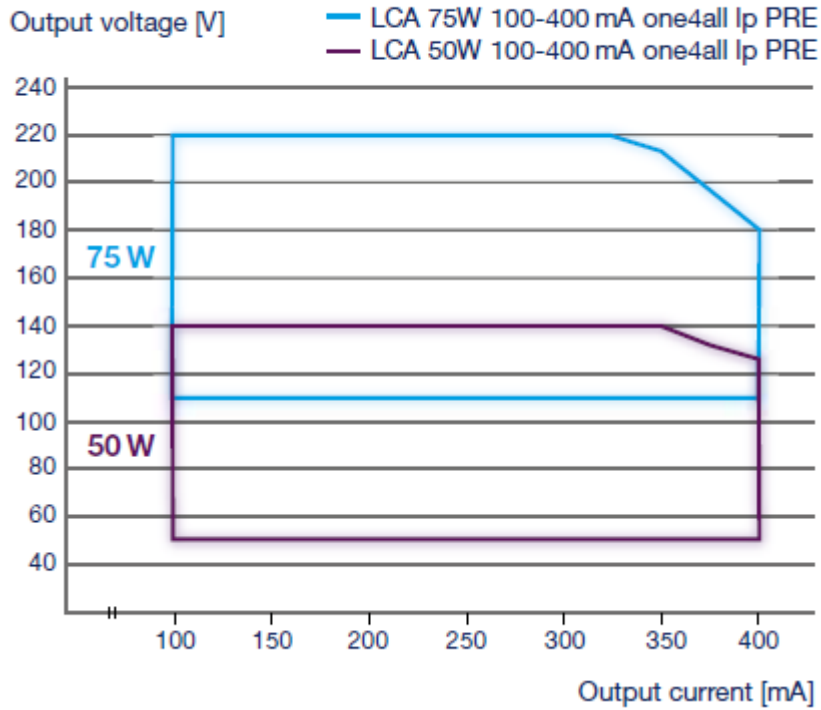

### Operating window 250-700 mA I<sub>p</sub>

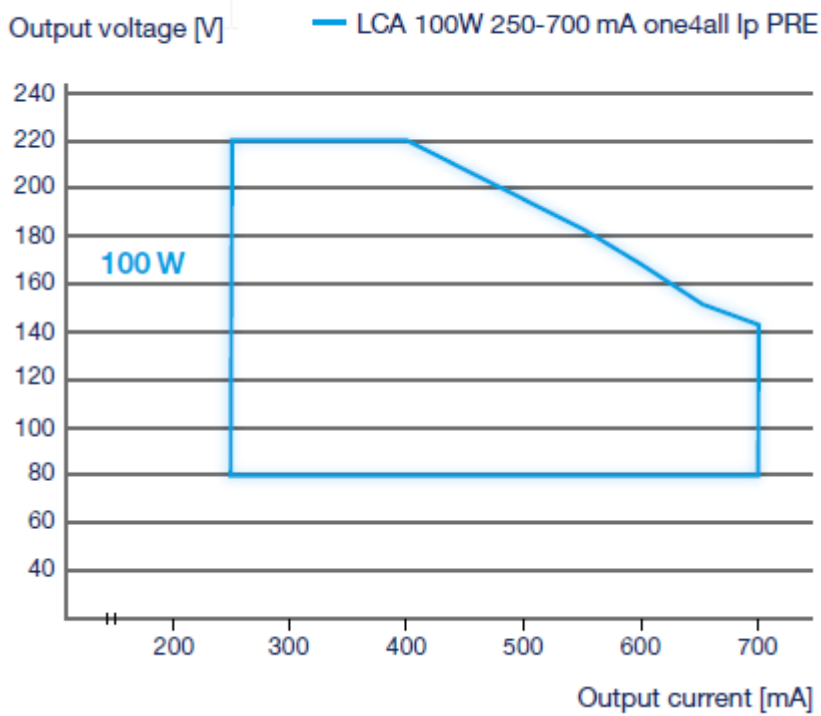

## Description of key features

### 3.5. Operating Window Multichannel

The new Multichannel devices (DT 8 and 2/4 CH DT 6) differ from the normal standard LED Driver in certain points.

They make it possible to use more than one channel at one device. Due to this fact a different view of the operating window was chosen.

All Multichannel devices are equipped with an I-Select 2 Interface. The current set with this plug will be used for all channels with the same value.

#### 3.5.1. Multichannel – DT8 - LCA 50W 350–1050mA DT8 Ip PRE

This device has 1 DT8 output.

Both channels can be programmed with the max. output current as defined in the datasheet.

All multi channel devices are equipped with an I-SELECT 2 Interface. The current set with this plug will be used for all channels with the same value.

The colour can be set via DT8 colour temperature commands and colourSWITCH (see [colourSWITCH](#), S. ).

## Description of key features

This graph shows the operating window of the device.

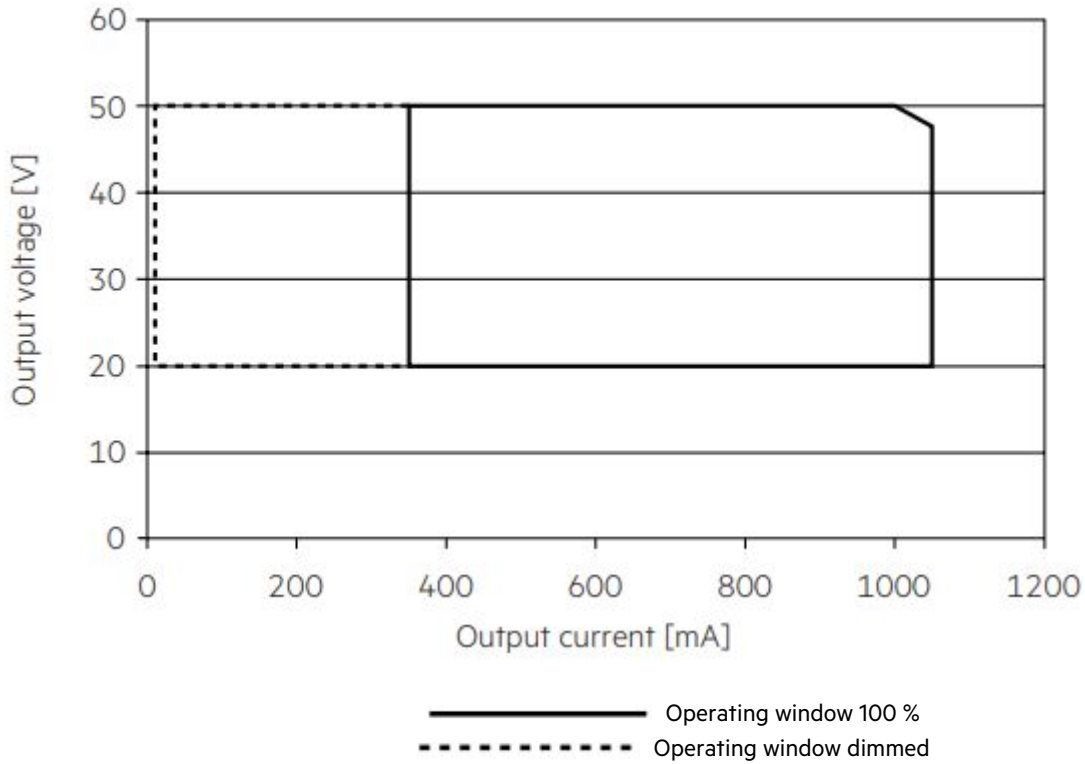

This graph shows the output power window of the device.

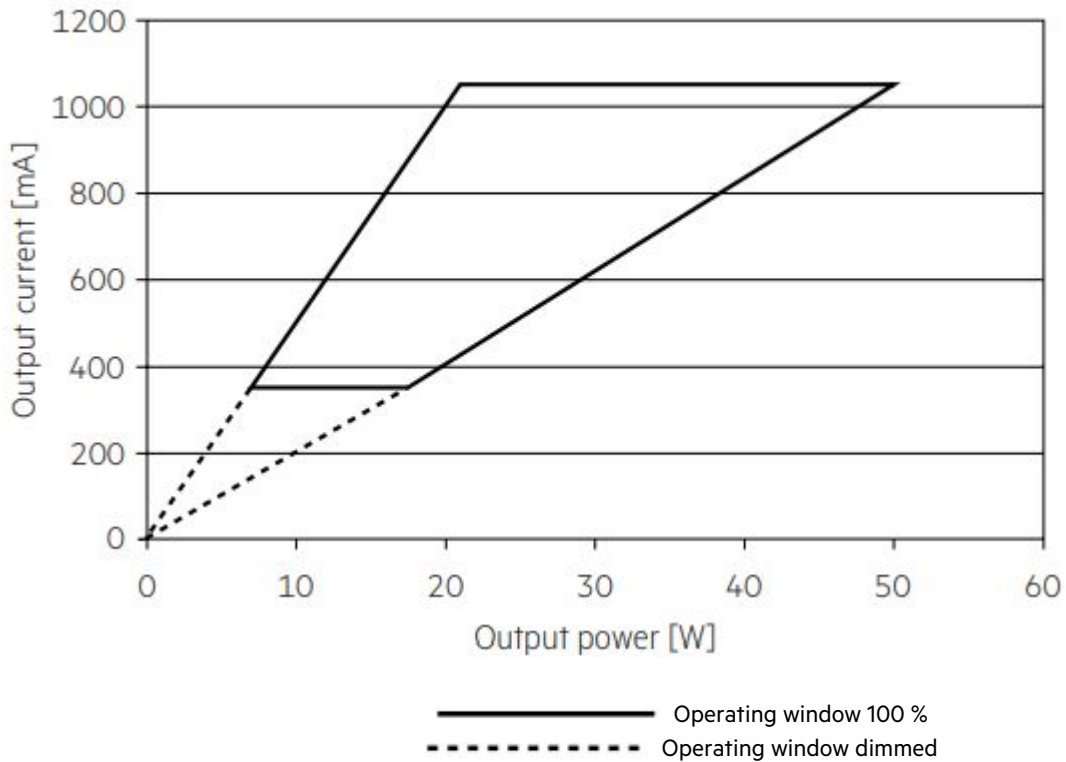

## Description of key features

Make sure that the LED Driver is operated within the given window under all operating conditions.

Special attention needs to be paid at dimming and DC emergency operation as the forward voltage of the connected LED modules varies with the dimming level,

due to the implemented amplitude dimming technology.

Coming below the specified minimum output voltage of the LED Driver may cause the device to shut-down.

### 3.5.2. Multichannel – 2xCH - LCA 50W 350–1050mA 2xCH Ip PRE

This device has two DT 6 output channels. Both channels can be programmed and operated separately.

There are 2 DALI addresses available and every channel can be programmed via DALI with its own current settings.

Both channels can be programmed with the max. output current as defined in the datasheet.

All Multichannel devices are equipped with an I-Select 2 Interface. The current set with this plug will be used for all channels with the same value.

This graph shows the operating window of the device.

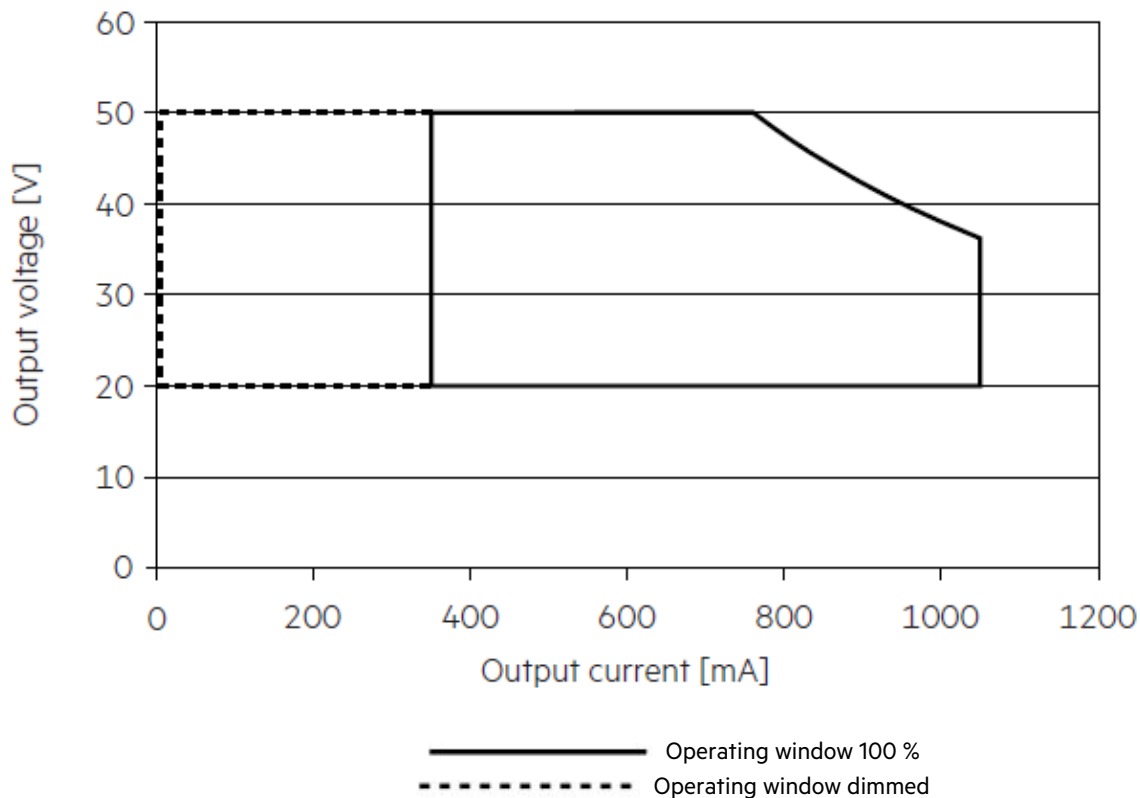

When using both channels, the second graph has to be used because the power of the device will be reduced depending on the current and forward voltage selection.

Make sure not to overload the device with high output currents on both channels. Always calculate summary values for current and forward voltage for our used channels.

If a wrong setup was stored and the driver would be overloaded, the second Channel (2) will reduce the output power automatically to protect the device.



## Description of key features

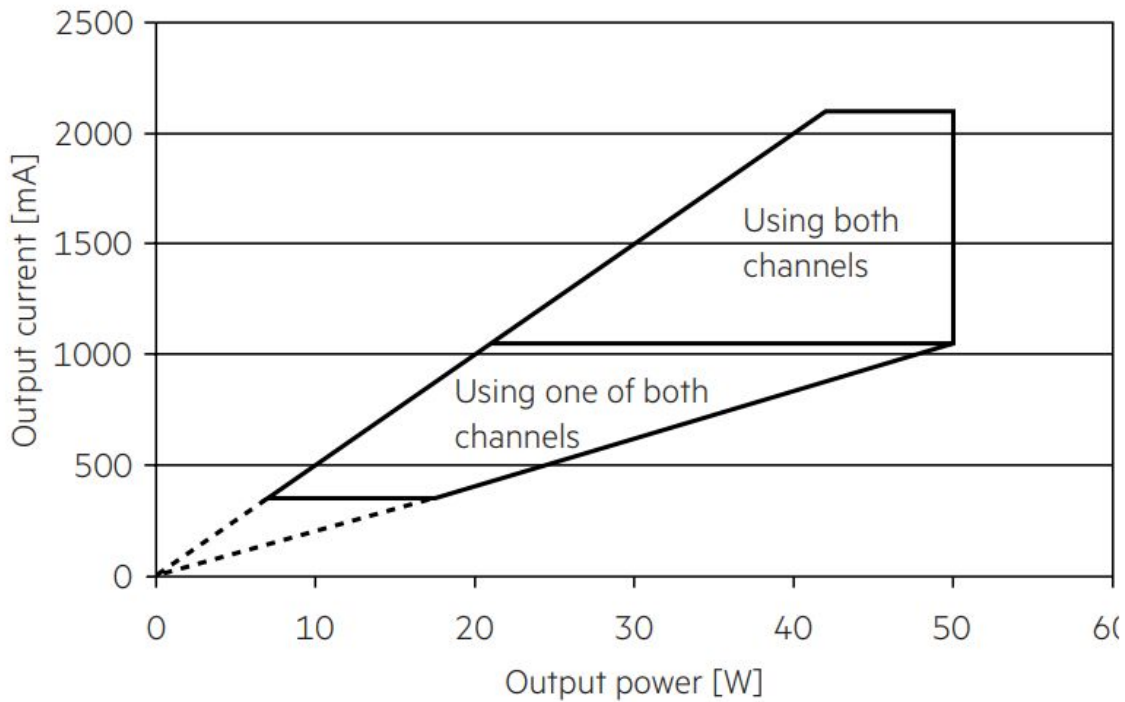

### 3.5.3. Multichannel – LCA 100W 350–1050mA 2xDT8 Ip PRE

This device has 2 DT8 outputs.

Output 1+2 will be seen as one DT8 channel and output 3+4 will be seen as the other DT8 channel.

The colour can be set with color temperature commands via DALI.

The device has two DT8 DALI addresses. The current can be programmed via DALI for all four output channels with the max. output current as defined in the datasheet.

All multichannel devices are equipped with an I-Select 2 Interface. The current set with this plug will be used for all channels with the same value.

## Description of key features

This graph shows the operating window of the device.

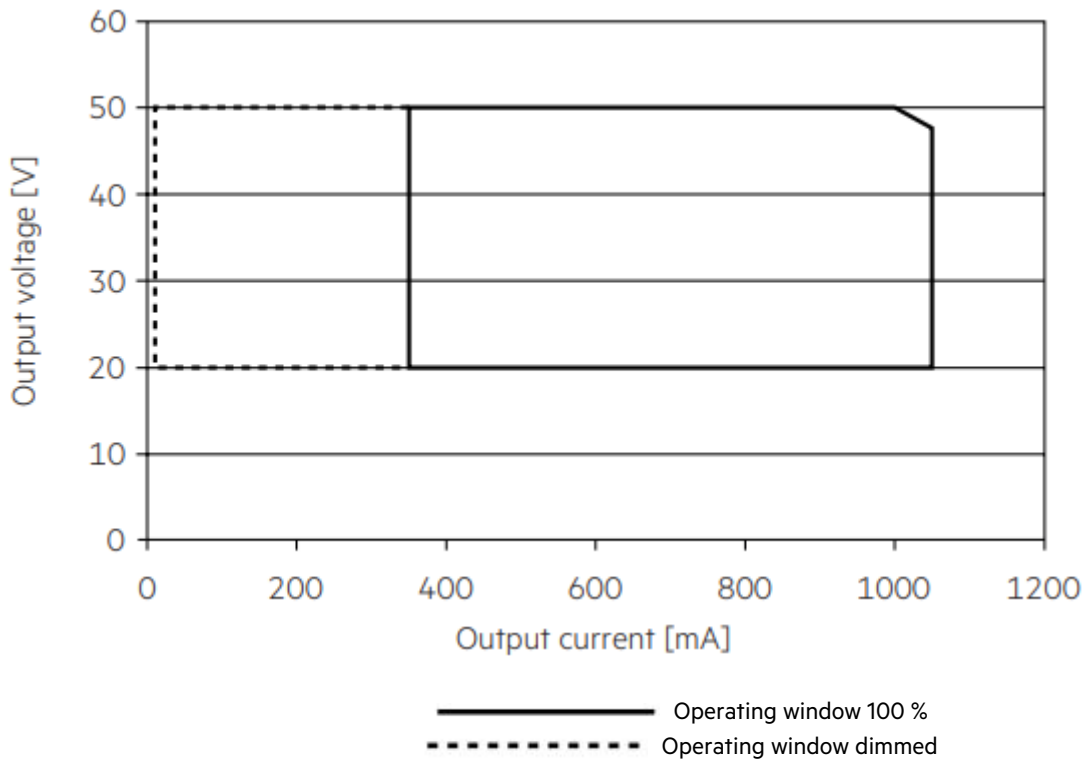

When using both channels, you have to use the second graph, because the power of the device will be reduced depending on your current and forward voltage selection.

Make sure not to overload the device with too high output currents on both channels. Always calculate summary values for current and forward voltage for your used channels.

If a wrong setup was stored and the driver would be overloaded, the second output Channel (2) and the fourth output Channel (4) will reduce the output power automatically to protect the device.

Channel 2+4 is the same colour and so an indication is clearly visible while reducing the output power.

## Description of key features

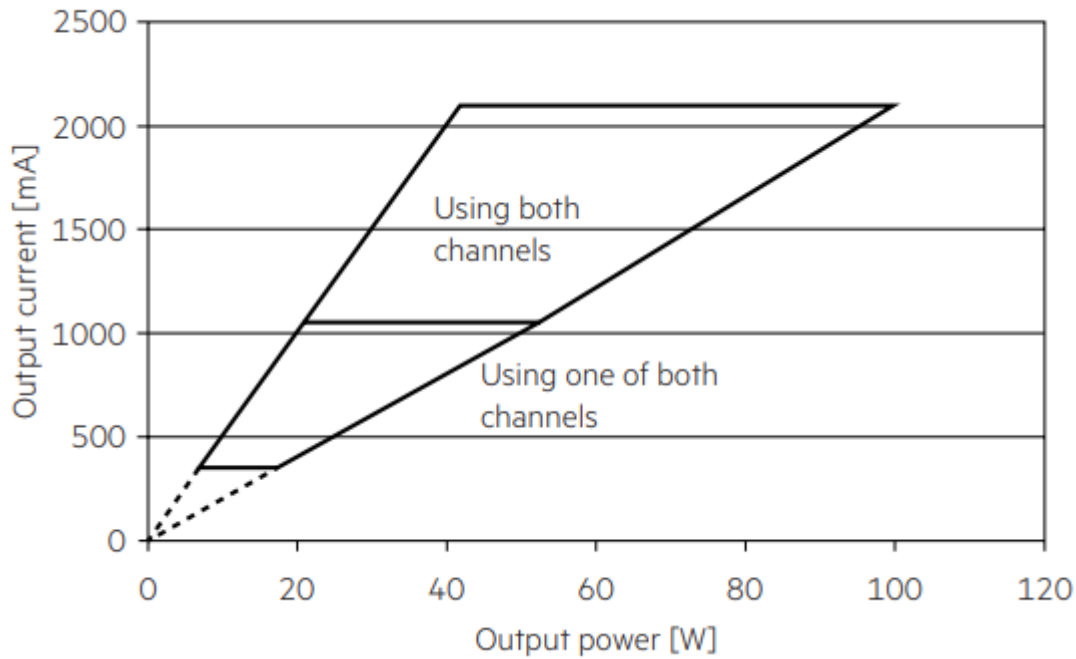

### 3.5.4. Multichannel – 4xCH - LCA 100W 350–1050mA 4xCH Ip PRE

This device has four DT 6 output channels. All channels can be programmed and operated separately.

There are 4 DALI addresses available and every channel can be programmed via DALI with its own current settings.

All channels can be operated with the max. output current as defined in the datasheet.

All Multichannel devices are equipped with an I-Select 2 Interface. The current set with this plug will be used for all channels with the same values.

## Description of key features

This graph shows the operating window of the device.

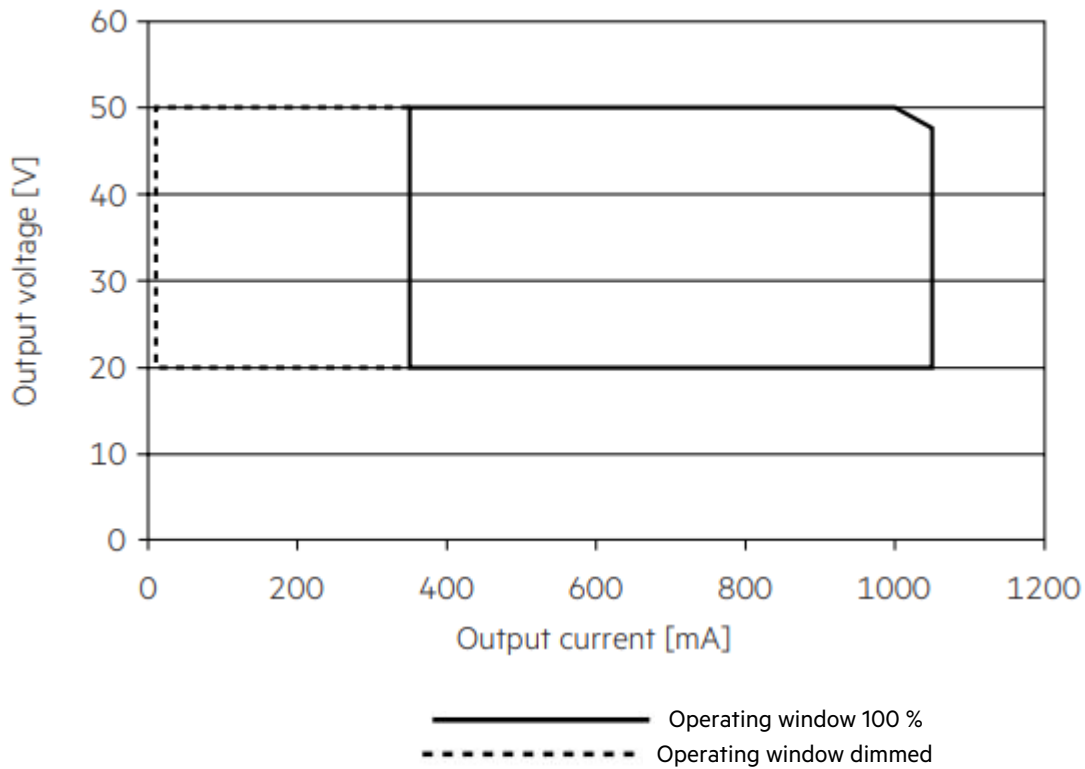

When using all four channels you have to use the second graph, because the power of the device will be reduced depending on your current and forward voltage selection.

Make sure not to overload the device with too high output currents on both channels. Always calculate summary values for current and forward voltage for your used channels.

If a wrong setup was stored and the driver would be overloaded, the second output Channel (2) and the fourth output Channel (4) will reduce the output power automatically to protect the device.

## Description of key features

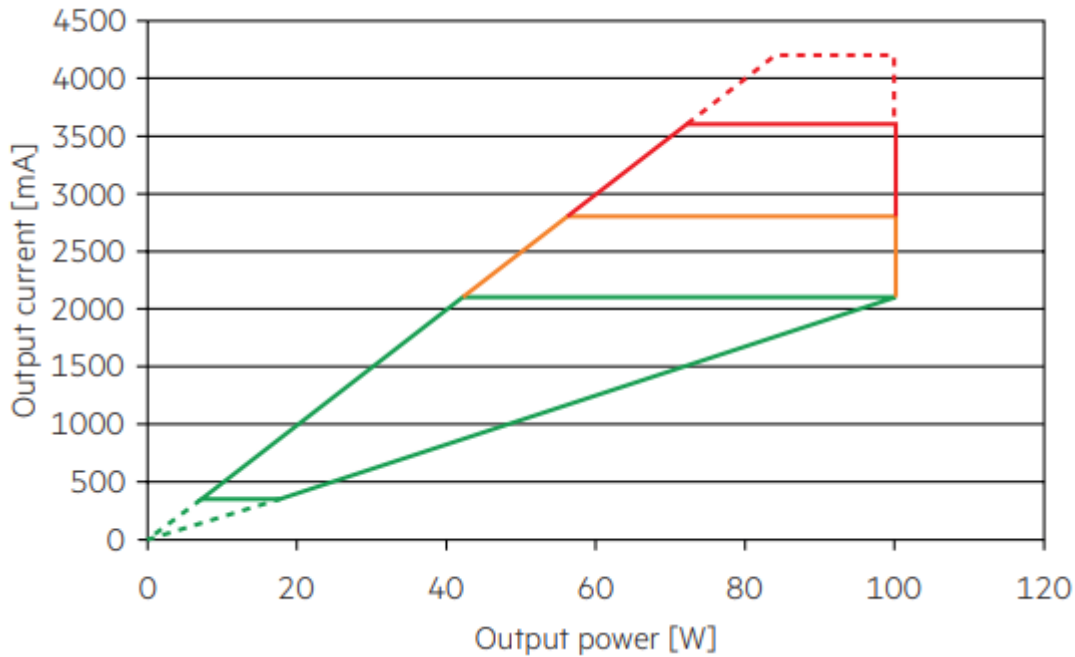

- \_ Green area: The green area is an operation with up to four channels (this table also refers to the table on page 2).
- \_ Orange area: The orange area is then the first area thermally limited by the 3 – 4 channel operation.
- \_ Red area: The red area is the area that is thermally even more limited by the 3 – 4 channel operation.
- \_ Red dotted area: The red dotted area is the area that is thermally very strong limited by the 4 channel operation.

### **i** NOTICE

By using more channels and higher output power, the temperature range could be decreased very strongly. Details see in the lifetime table.

## Description of key features

With increasing performance and use of all channels, the temperature range is severely limited. Details can be taken from the "Expected life-time" table.

| Type                                       | Output current<br>(CH1 + CH2 + CH3 +<br>CH4) | ta        | 30 °C      | 35 °C      | 40 °C      | 50 °C    | 60 °C    |
|--------------------------------------------|----------------------------------------------|-----------|------------|------------|------------|----------|----------|
| <b>LCA 100W 350-1050mA 4xCH<br/>Ip PRE</b> | 700 – 1,400 mA                               | tc        | 50 °C      | 55 °C      | 60 °C      | 70 °C    | 80 °C    |
|                                            |                                              | Life-time | >100,000 h | >100,000 h | >100,000 h | 95,000 h | 50,000 h |
|                                            | 1,400 – 1,800 mA                             | tc        | 55 °C      | 60 °C      | 65 °C      | 75 °C    | 85 °C    |
|                                            |                                              | Life-time | >100,000 h | >100,000 h | >100,000 h | 50,000 h | 25,000 h |
|                                            | 1,800 – 2,100 mA                             | tc        | 60 °C      | 65 °C      | 70 °C      | 80 °C    | 90 °C    |
|                                            |                                              | Life-time | >100,000 h | 90,000 h   | 65,000 h   | 40,000 h | 25,000 h |
|                                            | 2,100 – 2,800 mA                             | tc        | 60 °C      | 65 °C      | 70 °C      | 85 °C    | -        |
|                                            |                                              | Life-time | 80,000 h   | 55,000 h   | 40,000 h   | 20,000 h | -        |
|                                            | 2,800 – 3,600 mA                             | tc        | 65 °C      | 70 °C      | 75 °C      | -        | -        |
|                                            |                                              | Life-time | 40,000 h   | 30,000 h   | 20,000 h   | -        | -        |
|                                            | 3,600 – 4,200 mA                             | tc        | 70 °C      | 75 °C      | -          | -        | -        |
|                                            |                                              | Life-time | 20,000 h   | 15,000 h   | -          | -        | -        |

## Compatibility between module and LED Driver

There are two stages involved in the check for compatibility between the LED module and the LED Driver.

- \_ The requirements for operating together can be checked by comparing the data sheets
- \_ Subsequent practical tests can ensure that there are no unexpected problems during actual operation

### 4.1. Comparison of data sheet values with a 4-point guideline

Different values for the two devices need to be considered when comparing the data sheets. The following table shows which values are involved and which requirements they must meet.

| Comparison of... | Value in light module   |    | Value in LED Driver         | Detailed procedure                                                                                                                                                                                                                                                       |
|------------------|-------------------------|----|-----------------------------|--------------------------------------------------------------------------------------------------------------------------------------------------------------------------------------------------------------------------------------------------------------------------|
| (1) Current      | $I_{max}$               | =  | Output current              | <ul style="list-style-type: none"> <li>_ Determine forward current of LED module</li> </ul>                                                                                                                                                                              |
|                  | Max. DC forward current | >= | Output current + tolerances | <ul style="list-style-type: none"> <li>_ Check whether LED Driver can be operated with the same output current</li> <li>_ Check whether max. DC forward current of LED module is greater than or equal to output current of LED Driver (including tolerances)</li> </ul> |

**⚠ CAUTION!**

The max. DC forward current can be temperature dependent!  
Refer to the derating curve of the LED module data sheet (see [Reference list, S. 71](#)).

continue... ->

## Compatibility between module and LED Driver

| Comparison of...      | Value in light module                |    | Value in LED Driver               | Detailed procedure                                                                                                                                                                                                                                                                                                                                                                                                                                                                                                                                                                                                                                                           |
|-----------------------|--------------------------------------|----|-----------------------------------|------------------------------------------------------------------------------------------------------------------------------------------------------------------------------------------------------------------------------------------------------------------------------------------------------------------------------------------------------------------------------------------------------------------------------------------------------------------------------------------------------------------------------------------------------------------------------------------------------------------------------------------------------------------------------|
| (2) Voltage           | Min. forward voltage                 | >  | Min. output voltage               | <ul style="list-style-type: none"> <li>Check whether voltage range of LED module is completely within the voltage range of LED Driver</li> </ul>                                                                                                                                                                                                                                                                                                                                                                                                                                                                                                                             |
|                       | Max. forward voltage                 | <  | Max. output voltage               | <div style="border: 1px solid yellow; padding: 5px;"> <p><b>⚠ CAUTION!</b></p> <p>The forward voltage is temperature dependent!<br/>Refer to the <math>V_f/t_p</math> diagram in the data sheet (see <a href="#">Reference list</a>, S. 71).</p> </div>                                                                                                                                                                                                                                                                                                                                                                                                                      |
|                       | Min. forward voltage @ min. dimlevel | >  | Min. output voltage               | <div style="border: 1px solid blue; padding: 5px;"> <p><b>i NOTICE</b></p> <p>To ensure full dimming performance the forward voltage of the LED module at min. dim level must be greater than or equal to the min. output voltage of the driver (PRE only).</p> </div> <ul style="list-style-type: none"> <li>Determine the forward voltage of the LED module at lowest dim level</li> <li>In case there is no data available for the LED module at lowest dim level: take the min. forward voltage minus 20 % as an approximation</li> <li>Check whether the forward voltage of the LED module is greater than or equal to the min. output voltage of the driver</li> </ul> |
| (3) LF current ripple | Max. permissible LF current ripple   | >= | Output LF current ripple (<120Hz) | <ul style="list-style-type: none"> <li>Check whether max. permissible LF current ripple of LED module is greater than or equal to output LF current ripple of LED Driver</li> </ul>                                                                                                                                                                                                                                                                                                                                                                                                                                                                                          |
| (4) Max. peak current | Max. permissible peak current        | >  | Max. output current peak          | <ul style="list-style-type: none"> <li>Check whether max. permissible peak current of LED module is greater than max. output current peak of LED Driver</li> </ul>                                                                                                                                                                                                                                                                                                                                                                                                                                                                                                           |



## Compatibility between module and LED Driver

### 4.2. Application of the 4-point guideline

The compatibility check with the 4-point guideline is shown here using two examples.

#### 4.2.1. Example 1

Comparison data for LED Driver

| LED Driver   |                           |
|--------------|---------------------------|
| Designation  | LCI 20W 350mA-900mA TOP C |
| Manufacturer | TRIDONIC                  |



| Data sheet values of LED Driver |                     |
|---------------------------------|---------------------|
| Output current                  | 500 mA              |
| Output current tolerance        | ± 5 %               |
| Min. output voltage             | 18 V <sup>(1)</sup> |
| Max. output voltage             | 40 V <sup>(1)</sup> |
| Output LF current ripple        | ± 2 %               |
| Max. output current peak        | 600 mA              |

<sup>(1)</sup> Values at 500mA

## Compatibility between module and LED Driver

### Comparison data for LED module

| LED module   |                       |
|--------------|-----------------------|
| Designation  | Fictitious LED module |
| Manufacturer | Other manufacturer    |



| Data sheet values of LED module    |                                |
|------------------------------------|--------------------------------|
| Forward current                    | 500 mA                         |
| Max. DC forward current            | 1,050 mA                       |
| Typ. forward voltage               | 33 V $\pm$ 10 % <sup>(1)</sup> |
| Min. forward voltage               | 29.7 V <sup>(1)</sup>          |
| Max. forward voltage               | 36.3 V <sup>(1)</sup>          |
| Max. permissible LF current ripple | 630 mA                         |
| Max. permissible peak current      | 1,500 mA                       |

<sup>(1)</sup> Values at 500mA

### Questions

- \_ Are the two components mutually compatible?
- \_ Can the required luminous flux of 1,510 lm be achieved with this combination?

## Compatibility between module and LED Driver

### Procedure

#### Comparison of data sheet values

| Comparison of...      | Value in light module |    | Value in LED Driver | Result | Explanation                                                                                                                                                                                                                                                                                              |
|-----------------------|-----------------------|----|---------------------|--------|----------------------------------------------------------------------------------------------------------------------------------------------------------------------------------------------------------------------------------------------------------------------------------------------------------|
| (1) Current           | 500 mA                | =  | 500 mA              | ✓      | <ul style="list-style-type: none"> <li>To produce a luminous flux of 1,510 lm the light module must be operated with a forward current of 500 mA.</li> <li>The LED Driver can be set so that it delivers precisely this value of 500 mA as the output current (with a resistance of 49.90 k).</li> </ul> |
|                       | 1,050 mA              | >= | 525 mA              | ✓      | <ul style="list-style-type: none"> <li>The output current of the LED Driver including tolerances (500 mA + 5 % = 525 mA) is less than or equal to the max. DC forward current of the light module (1,050 mA).</li> </ul>                                                                                 |
| (2) Voltage           | 29.7 V                | >  | 18 V                | ✓      | <ul style="list-style-type: none"> <li>The voltage range of the light module (29.7 V - 36.3 V) lies completely within the voltage range of the LED Driver (18 V - 40.0 V).</li> </ul>                                                                                                                    |
|                       | 36.3 V                | <  | 40 V                | ✓      |                                                                                                                                                                                                                                                                                                          |
| (3) LF current ripple | 630 mA                | >  | 535.5 mA            | ✓      | <ul style="list-style-type: none"> <li>The Output LF current ripple (2 % of output current plus tolerances: <math>[500 \text{ mA} + 5 \%] \times 1.02 = 535.5 \text{ mA}</math>) of the LED Driver is less than the max. permissible LF current ripple of the LED module (630 mA).</li> </ul>            |
| (4) Max. peak current | 1,500 mA              | >  | 600 mA              | ✓      | <ul style="list-style-type: none"> <li>The max. output current peak of the LED Driver (500 mA + 20 % = 600 mA) is less than the max. permissible peak current with which the light module can be operated (1,500 mA).</li> </ul>                                                                         |

### Result

All the values meet the requirements. The components are mutually compatible.

## Compatibility between module and LED Driver

### 4.2.2. Example 2

#### Comparison data for LED Driver

| LED Driver   |                           |
|--------------|---------------------------|
| Designation  | LCI 20W 350mA-900mA TOP C |
| Manufacturer | TRIDONIC                  |



| Data sheet values of LED Driver |                     |
|---------------------------------|---------------------|
| Output current                  | 500 mA              |
| Output current tolerance        | ± 5 %               |
| Min. output voltage             | 18 V <sup>(1)</sup> |
| Max. output voltage             | 40 V <sup>(1)</sup> |
| Output LF current ripple        | ± 2 %               |
| Max. output current peak        | 600 mA              |

<sup>(1)</sup> Values at 500mA

#### Comparison data for LED module

| LED module   |                       |
|--------------|-----------------------|
| Designation  | Fictitious LED module |
| Manufacturer | Other manufacturer    |



| Data sheet values of LED module    |                             |
|------------------------------------|-----------------------------|
| Forward current                    | 500 mA                      |
| Max. DC forward current            | 1,050 mA                    |
| Typ. forward voltage               | 39.5 V ±10 % <sup>(1)</sup> |
| Min. forward voltage               | 35.55 V <sup>(1)</sup>      |
| Max. forward voltage               | 43.45 V <sup>(1)</sup>      |
| Max. permissible LF current ripple | 630 mA                      |
| Max. permissible peak current      | 1,500 mA                    |

<sup>(1)</sup> Values at 500mA

## Compatibility between module and LED Driver

### Questions

- \_ Are the two components mutually compatible?
- \_ Can the required luminous flux of 1,800 lm be achieved with this combination?

## Compatibility between module and LED Driver

### Procedure

#### Comparison of data sheet values

| Comparison of...      | Value in light module |    | Value in LED Driver | Result | Explanation                                                                                                                                                                                                                                                                                              |
|-----------------------|-----------------------|----|---------------------|--------|----------------------------------------------------------------------------------------------------------------------------------------------------------------------------------------------------------------------------------------------------------------------------------------------------------|
| (1) Current           | 500 mA                | =  | 500 mA              | ✓      | <ul style="list-style-type: none"> <li>To produce a luminous flux of 1,800 lm the light module must be operated with a forward current of 500 mA.</li> <li>The LED Driver can be set so that it delivers precisely this value of 500 mA as the output current (with a resistance of 49.90 k).</li> </ul> |
|                       | 1,050 mA              | >= | 525 mA              | ✓      | <ul style="list-style-type: none"> <li>The output current of the LED Driver including tolerances (500 mA + 5 % = 525 mA) is less than or equal to the max. DC forward current of the light module (1,050 mA).</li> </ul>                                                                                 |
| (2) Voltage           | 35.55 V               | >  | 18 V                | ✓      | <ul style="list-style-type: none"> <li>The voltage range of the light module (35.55 V - 43.45 V) is <b>not</b> within the voltage range of the LED Driver (18 V - 40.0 V)</li> </ul>                                                                                                                     |
|                       | 43.45 V               | <  | 40 V                | ✗      |                                                                                                                                                                                                                                                                                                          |
| (3) LF current ripple | 630 mA                | >  | 535.5 mA            | ✓      | <ul style="list-style-type: none"> <li>The Output LF current ripple (2 % of output current plus tolerances: <math>[500 \text{ mA} + 5 \%] \times 1.02 = 535.5 \text{ mA}</math>) of the LED Driver is less than the max. permissible LF current ripple of the LED module (630 mA).</li> </ul>            |
| (4) Max. peak current | 1,500 mA              | >  | 600 mA              | ✓      | <ul style="list-style-type: none"> <li>The max. output current peak of the LED Driver (500 mA + 20 % = 600 mA) is less than the max. permissible peak current with which the light module can be operated (1,500 mA).</li> </ul>                                                                         |

### Result

One of the values **does not** meet the requirements. The components are **not** mutually compatible.

## Compatibility between module and LED Driver

### 4.3. Practical tests

Practical tests are used to ensure fault-free operation of the light module and LED Driver. The following aspects must be checked.

#### 4.3.1. Technical aspects

- \_ Transient behaviour
- \_ Colour shift
- \_ Connection during operation
- \_ Parasitic capacitance

#### 4.3.2. Visual aspects

- \_ Flickering
- \_ Stroboscopic effect (video applications)
- \_ Dimming behaviour (PRE only)
- \_ Colour change/stability
- \_ Luminous flux

#### 4.3.3. Conditions

When conducting the tests the following conditions must be considered:

- \_ All tolerances
- \_ Entire temperature range
- \_ Different output voltage ranges (incl. no load)
- \_ Entire dimming range (PRE only)
- \_ Short circuit

#### NOTICE

If the values are slightly over or under the specified threshold values or if there are any other concerns or questions please contact Technical Support: [techservice@tridonic.com](mailto:techservice@tridonic.com)

## Installation notes

### NOTICE

The cabling, wiring and mounting for a LED driver varies depending on the design and manufacturer of the LED module. The following description should therefore not be viewed as comprehensive installation instructions but merely as important general information.

To obtain further information, proceed as follows:

- \_ Read the documentation provided by the lamp manufacturer. Follow the guidelines and instructions of the lamp manufacturer!
- \_ Observe all relevant standards. Follow the instructions given in the standards!

## 5.1. Safety information

### WARNING!

- \_ Comply with the general safety instructions (see [General safety instructions](#), S. 5) !
- \_ To avoid failures due to ground faults protect the wiring against mechanical loads from sharp-edged metal parts (e.g. cable penetrations, cable holders, metal frames, etc.
- \_ Electronic LED Driver from Tridonic are protected for a maximum of 48 hour against overvoltage of up to 320 V. Make sure that the LED Driver is not exposed to overvoltages for long periods!
- \_ Electronic LED Driver LCA PRE, LC EXC from Tridonic have type of protection IP 20. Comply with the requirements for this type of protection!



## Installation notes

### 5.2. Function of the earth terminal



The earth connection is conducted as protection earth (PE). The LED Driver can be earthed via earth terminal or metal housing (if device has metal housing). If the LED Driver will be earthed, protection earth (PE) has to be used. There is no earth connection required for the functionality of the LED Driver. Earth connection is recommended to improve following behaviour.

- \_ Electromagnetic interferences (EMI)
- \_ LED glowing at standby
- \_ Transmission of mains transients to the LED output

In general it is recommended to earth the LED Driver if the LED module is mounted on earthed luminaire parts respectively heat sinks and thereby representing a high capacity against earth.

#### 5.2.1. Avoiding residual LED glow on standby

Residual LED glow on standby may occur as a result of capacitive leakage currents from the LED module onto earthed luminaire parts (such as the heat sink). This mainly affects high-efficiency LED systems with large surface areas installed in luminaires with protection class 1.

The topology has been improved so that residual LED glow can be virtually eliminated by earthing the devices.

#### **i** NOTICE

If the LED driver cannot be earthed or if earthing is not desired, residual LED glow can be minimised by adequate insulation (for example by using heat-conducting double-sided insulation foil).

#### 5.2.2. Avoiding the transfer of mains transients to the LED output

The transfer of mains transients to the LED output presents a problem for many LED driver topologies currently on the market, and TRIDONIC devices may be affected.

Voltage peaks at the input of the LED driver may be transferred to the output of the device where they lead to differences in potential between the LED output and earthed luminaire parts. These differences in potential may result in flashovers if the insulation is inadequate or if the creepage and clearance distances are too small. Flashovers will cause the LED module to fail.

Earthing the LED driver attenuates voltage peaks and reduces the likelihood of flashovers. The precise degree of attenuation depends on the capacitance of the LED module with respect to earth. If voltages at the output are higher than 0.5 kV, it is mentioned in the data sheet.

## Installation notes

Figure: Voltage peaks for LED driver without earthing (left) and with earthing (right)

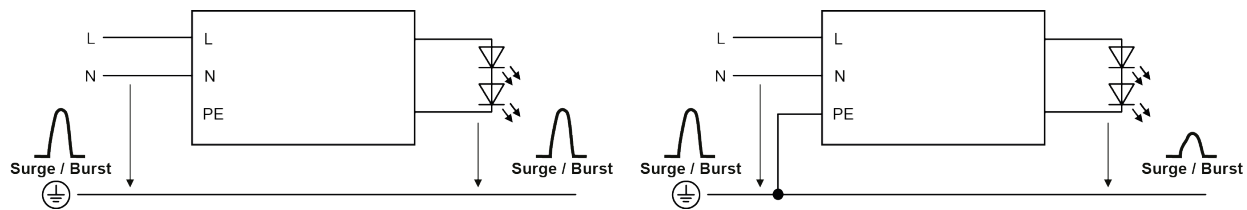

### **i** NOTICE

Irrespective of whether the LED driver is earthed or not, LED modules must be insulated in accordance with the requirements of the luminaire protection class. Improved insulation of the LED module can also reduce the likelihood of flashovers.

## Installation notes

### 5.3. Routing the wires

#### 5.3.1. Tests

##### **i** NOTICE

The performance of the prescribed tests and compliance with relevant standards are the responsibility of the luminaire manufacturer.

The following descriptions merely indicate the most important tests and are no substitute for a full research of the relevant standards.

#### 5.3.2. Insulation and dielectric strength testing of luminaires

LED driver for lamps are sensitive to high-voltage transients. This must be taken into consideration when subjecting luminaires to routine testing during manufacture.

According to IEC 60598-1 Annex Q (for information only!) and ENEC 303-Annex A, each luminaire should be subjected to an insulation test for 1 second at 500 V DC. The test voltage is applied between the linked phase/neutral conductor terminal and the protective earth terminal. The insulation resistance must be at least 2 megaohm.

As an alternative to measuring the insulation resistance, IEC 60598-1 Annex Q describes a dielectric strength test at 1500 V AC (or  $1.414 \times 1,500$  V DC). To avoid damaging electronic LED Driver, this dielectric strength test should be performed exclusively for type testing. This test should certainly not be used for routine testing.

##### **i** NOTICE

Tridonic recommends performing an insulation test because a dielectric strength test may damage the device irreparably.

#### 5.3.3. Type testing

Type testing of the luminaire is performed according to IEC 60598-1 Section 10.

The wiring for protection class 1 luminaires is tested at a voltage of  $2xU + 1,000$  V. In order not to overload the LED Driver all the inputs and outputs of the LED Driver are connected to one another.

$U_{out}$  is used for measuring the voltage for luminaires with LED Driver with  $U_{out} > 250$  V:

For  $U_{out} 480$  V the voltage for the type test is 2000 V. (Routine testing is always performed at 500 V DC)

#### 5.3.4. Wiring

##### **i** NOTICE

The wiring procedure is device specific. Further information about wiring, wire cross sections and the length of stripped off insulation can be found in the data sheet.

## Installation notes

### Wiring guidelines

- \_ The cables should be run separately from the mains connections and mains cables to ensure good EMC conditions.
- \_ The LED wiring should be kept as short as possible to ensure good EMC. The max. secondary cable length is 2 m (4 m circuit), this applies for LED output as well as for I-select and temperature sensor.
- \_ Depending on the design of the luminaire it may be possible to improve the radio interference properties by earthing the device at the earth connection.
- \_ The LED driver has no inverse-polarity protection on the secondary side. Wrong polarity can damage LED modules with no inverse-polarity protection.

### Wiring the plug-in terminal

- \_ Use solid wire or stranded wire with the correct cross-section
- \_ Strip off correct length of insulation; you may need to twist the tool slightly
- \_ If stranded wire is used: push onto the terminal from above to be able to insert the wire
- \_ Insert the bare end into the terminal

### Detaching the plug-in terminal

- \_ Push onto the terminal from above to release the wire
- \_ Pull out the wire at the front

## 5.4. External fuse for DC operation

The internal fuse of an LED Driver is not rated for DC operation. Because of this, an additional external fuse must be used if an LED Driver is operated on a DC network.

Proceed as follows:

- \_ Connect the external fuse to the line labeled "+" which is between the DC power supply and the input terminal of the LED Driver
- \_ Only use an external fuse with suitable parameters.

For LED Drivers with a power of 25-150 watts the following values are recommended:

- \_ Rated voltage: 250 V
- \_ DC rated power: 1 A - 3 A Time-Lag (SLO-Blo®)

Tridonic recommends the following external fuse:

- \_ 477 Series, 5 × 20 mm, Time-Lag (Slo-Blo®) Fuse Rating 3.15 A

## Installation notes

### 5.5. Maximum loading of circuit breakers

#### 5.5.1. Importance of maximum loading

A circuit breaker is an automatically operated electrical switch that protects an electrical circuit from damage caused by overload or short circuit. Unlike a fuse that must be replaced if it triggers, a circuit breaker can be reset (either manually or automatically) and used further. Circuit breakers are available in different sizes and with different technical data.

The inrush current is a short increased peak current that occurs when an electronic control gear is switched on.

In electrical installations, numerous control gear are connected to one circuit breaker. The maximum loading of a circuit breaker indicates how many control gear can be connected to the circuit breaker without triggering the circuit breaker because of the summation of the different inrush currents. The value is calculated through simulation programs based on the circuit breakers characteristic.

Information about the maximum loading can be found in Tridonic data sheets. The following table shows the data for LCA 50W 100-400mA one4all Ip PRE as an example

| Automatic circuit breaker type   | C10                    | C13                    | C16                    | C20                    | B10                    | B13                    | B16                    | B20                    | Inrush current   |        |
|----------------------------------|------------------------|------------------------|------------------------|------------------------|------------------------|------------------------|------------------------|------------------------|------------------|--------|
| Installation Ø                   | 1.5<br>mm <sup>2</sup> | 1.5<br>mm <sup>2</sup> | 2.5<br>mm <sup>2</sup> | 2.5<br>mm <sup>2</sup> | 1.5<br>mm <sup>2</sup> | 1.5<br>mm <sup>2</sup> | 2.5<br>mm <sup>2</sup> | 2.5<br>mm <sup>2</sup> | I <sub>max</sub> | time   |
| LCA 50W 100-400mA one4all Ip PRE | 18                     | 26                     | 28                     | 34                     | 9                      | 13                     | 14                     | 17                     | 22.4 A           | 176 µs |

#### 5.5.2. Calculation of maximum loading

##### Tripping characteristics of circuit breakers

The load at which a circuit breaker triggers is defined by the height and the duration of the applied current.

The following table shows exemplary values for different circuit breakers (B10, B13, B16, B20).

| Duration<br>[µs] | Current B10<br>[A <sub>peak</sub> ] | Current B13<br>[A <sub>peak</sub> ] | Current B16<br>[A <sub>peak</sub> ] | Current B20<br>[A <sub>peak</sub> ] |
|------------------|-------------------------------------|-------------------------------------|-------------------------------------|-------------------------------------|
| 100              | 700                                 | 910                                 | 1,120                               | 1,400                               |
| 200              | 260                                 | 338                                 | 416                                 | 520                                 |
| 300              | 177                                 | 230.1                               | 283                                 | 354                                 |
| 400              | 145                                 | 188.5                               | 232                                 | 290                                 |
| 500              | 122                                 | 158.6                               | 195                                 | 244                                 |
| 600              | 110                                 | 143                                 | 176                                 | 220                                 |
| 700              | 102                                 | 132.6                               | 163                                 | 204                                 |

## Installation notes

|      |    |       |     |     |
|------|----|-------|-----|-----|
| 800  | 97 | 126.1 | 155 | 194 |
| 900  | 93 | 120.9 | 149 | 186 |
| 1000 | 90 | 117   | 144 | 180 |

The combination of both parameters can also be displayed graphically. This results in the tripping characteristic for a certain circuit breaker.

Current [A]

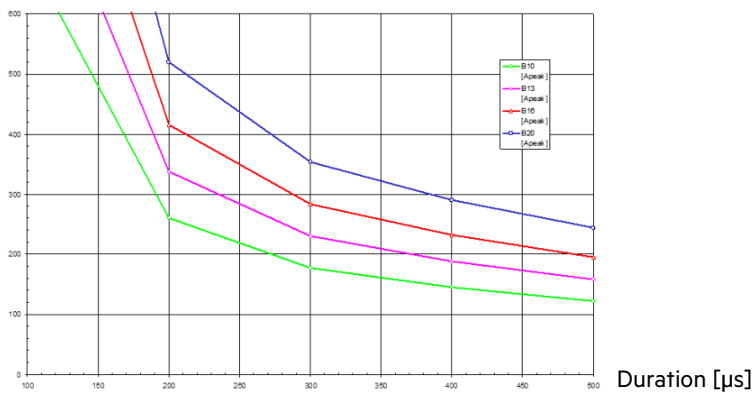

### NOTICE

Information about the specific tripping characteristics of a circuit breaker must be requested from the respective manufacturer !

### Calculation of the inrush current

The inrush current of a control gear is also defined by its duration and its height. The duration is typically measured as the time between 10 % of maximum current (ascending) and 50 % of maximum current (descending).

The following illustration shows the inrush current of a single control gear:

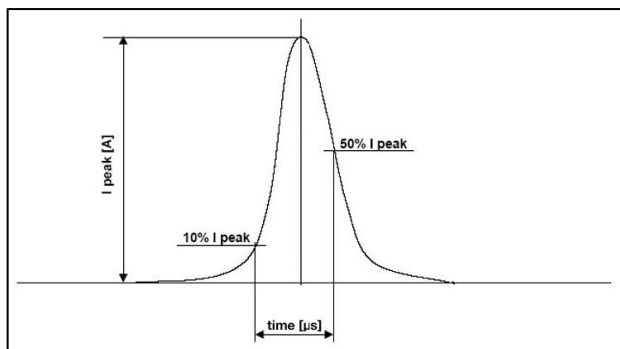

If several control gear are connected to one circuit breaker, the individual inrush currents add up.

## Installation notes

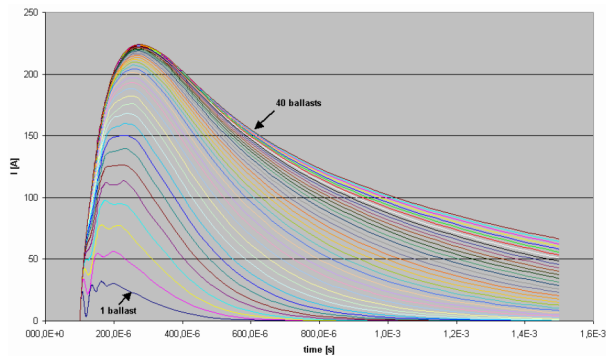

### Implementation of the simulation

The above-mentioned parameters, height and duration of the current pulse in both the circuit breaker and the control gear, are entered into the simulation program.

The result of the simulation is presented in graphical form.

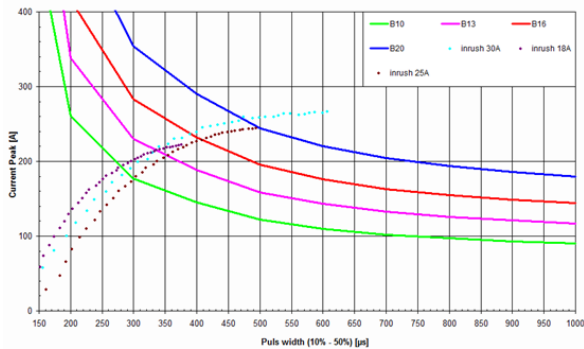

The different elements have the following meaning:

- \_ Circuit breaker:  
B10, B13, B16, B20 (solid line) represent the tripping characteristics of different circuit breakers.
- \_ Inrush current:  
The dotted lines represent different inrush currents.  
The index of a point signifies the number of LED Driver, that is, point 1 represents the result for 1 LED Driver, point 2 the result for 2 LED Driver, etc.

The simulation results can be read as follows:

- \_ The crossing of the two lines shows the maximum value for the selected combination of circuit breaker and inrush current.
- \_ The index of the point at this maximum value shows the max. number of ballasts.

The following example shows the maximum number of control gear at four different circuit breakers:

- \_ max. 5 devices at circuit breaker B10 (green tripping characteristic)
- \_ max. 7 devices at circuit breaker B13 (pink tripping characteristic)
- \_ max. 9 devices at circuit breaker B16 (red tripping characteristic)
- \_ max. 12 devices at circuit breaker B20 (blue tripping characteristic)

## Installation notes

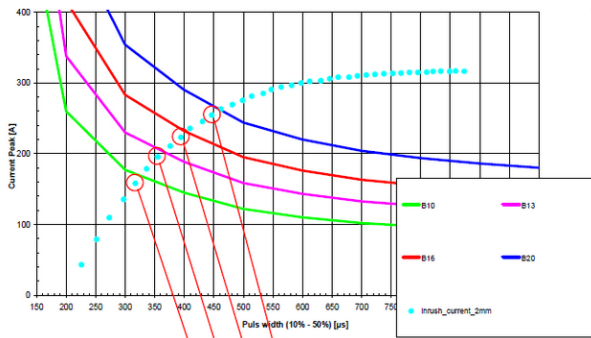

### NOTICE

The results of different simulations can only be compared if all of the relevant factors are the same. The following points can influence the results:

- \_ Tripping characteristic used for the circuit breakers
- \_ Definition used for the duration of the inrush current (Tridonic: 10-50 %)
- \_ Gear used for the measurement of the inrush current (especially important: Which electrolytic capacitor is installed in the LED Driver)
- \_ Considering a safety buffer (Tridonic: +20 % for the electrolytic capacitor )
- \_ Considering different system impedances
- \_ Switch-on point used: should always be at max. input voltage
- \_ Adopted cable lengths and cable data (Tridonic: Cable length 40 cm; Resistivity:  $0.0172 \text{ } \Omega \cdot \text{mm}^2 / \text{m}$ ; inductance: 5 nH / cm; terminal resistance: 2 m)
- \_ The modeling of the control gear is performed from the input to the bus voltage electrolytic capacitor. For inductance the saturation values must be used.



## Functions

### 6.1. corridorFUNCTION V2 (PRE only)

#### 6.1.1. Description

The corridorFUNCTION enables the illuminance to be linked to the presence or absence of people. A conventional relay motion sensor is connected. The luminous intensity is increased when a person enters the room. When the person leaves the room the motion sensor switches off after a certain delay and the luminous intensity is automatically reduced.

The corridorFUNCTION is particularly beneficial in applications in which light is needed round the clock for safety reasons, for example in public buildings, large apartment complexes, car parks, pedestrian underpasses and underground railway stations. Since the luminous intensity only has to be increased when there is a demand for light the corridorFUNCTION offers effective lighting management and helps saving energy and costs. Another benefit of the corridorFUNCTION is the enhanced convenience of automatic lighting control.

#### ⚠ CAUTION!

To ensure correct operation a sinusoidal mains voltage with a frequency of 50 Hz or 60 Hz is required at the control input. Special attention must be paid to achieving clear zero crossings. Serious mains faults may impair the operation of switchDIM and corridorFUNCTION.

#### Profile settings:

**Standard** profile for activating via 230V on the interface terminal DA/N - DA/L for 5 minutes is **"Never off"**

The LED Drivers have different profiles so they can provide the best possible performance in a range of conditions. The profiles are defined by a series of values:

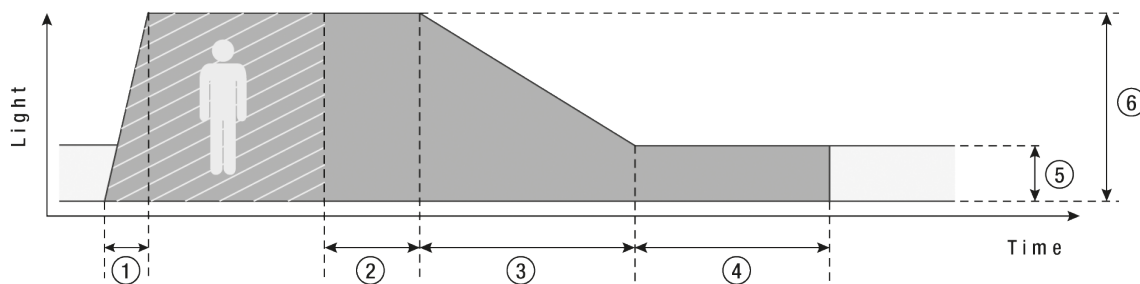

1. Fade-in time: the time that starts as soon as the presence of a person is detected. During the fade-in time the luminous intensity is faded up to the presence value (default: 0s).
2. Run-on time: the time that starts as soon as the presence of a person is no longer detected. If the presence of a person is detected again during the run-on time the run-on time is restarted from zero. If no presence is detected during the run-on time the fade time is started as soon as the run-on time expires.
3. Fade time: the time during which the luminous intensity is faded from the presence value to the absence value (default: 30 s).
4. Switch off delay: the time during which the absence value is held before the lighting is switched off. Depending on the profile selected the switch-off delay may have different values or may not be defined (default: "Never Off").
5. Absence value: the luminous intensity when there is no person present (default: 10 %).
6. Presence value: the luminous intensity when persons are present (default: 100 %).

## Functions

### Variable switch-off times

The profiles and their values can be freely adjusted. The values can be adjusted via a connection to a DALI bus.

## 6.1.2. Commissioning

### Activating the corridorFUNCTION

#### Procedure by means of the mains voltage

Activating the corridorFUNCTION is simple. If an a.c. voltage of 230 V is applied to the digital interface of the LED Driver for a period of at least 5 minutes the LED Driver detects the corridorFUNCTION and automatically activates it. Activation is required only once per device.

There are three procedures for activating by means of the mains voltage. The requirements are the same in each case.

#### Requirements:

- \_ The LED Driver is correctly installed in the luminaire
- \_ Input voltage is applied
- \_ A motion sensor is connected to information DA/N or DA/L

#### Procedure Version 1:

- \_ Remain in the activation range of the motion sensor for more than 5 minutes
  - > The motion sensor detects movement and switches on
  - > The corridorFUNCTION is activated automatically after 5 minutes
  - > The light value switches to presence level (default: 100 %)

#### Procedure Version 2:

- \_ Set the run-on time on the motion sensor to a value greater than 5 minutes
- \_ Remain in the activation range of the motion sensor for a short time
  - > The motion sensor detects movement and switches on
  - > The corridorFUNCTION is activated automatically after 5 minutes
  - > The light value switches to presence value (default: 100 %)
- \_ Reset the run-on time of the motion sensor to the required value

#### Procedure Version 3: Only possible if the motion sensor offers a manual override option

- \_ Set the slide switch on the motion sensor to the "Never-Off" function
- \_ Wait 5 minutes
  - > The corridorFUNCTION is activated automatically after 5 minutes
  - > The light value switches to presence value (default: 100 %)
- \_ Reset the slide switch on the motion sensor to the "automatic" function

#### Procedure via the masterCONFIGURATOR

The corridorFUNCTION can also be activated via the masterCONFIGURATOR.

Further information can be found in the masterCONFIGURATOR manual (see [Reference list](#), S. 71).

## Functions

### Deactivating the corridorFUNCTION

If the corridorFUNCTION is activated the LED Driver is controlled only by motion. To operate the LED Driver via DALI, DSI or switchDIM the corridorFUNCTION must be deactivated.

#### Procedure via mains

- \_ Connect mains voltage push button to the terminal marked DA/L
- \_ Connect neutral conductor to the terminal marked DA/N
- \_ Press the push button 5 times within 3 seconds

#### Procedure via DALI/DSI

- \_ Send 5 DALI or DSI commands within 3 seconds to the LED Driver

#### Procedure via masterCONFIGURATOR

If the corridorFUNCTION was activated via the masterCONFIGURATOR it can be deactivated as follows:

- \_ Send 5 DALI or DSI commands within 3 seconds to the LED Driver

### Adjusting the values of the corridorFUNCTION

The values of the corridorFUNCTION can be individually adjusted. The values are set via a DALI USB on the bus and by entering special DALI commands via the masterCONFIGURATOR.

Further information can be found in the masterCONFIGURATOR manual (see [Reference list](#), S. 71).

## Functions

### 6.1.3. Installation

#### Requirements:

- \_ The LED Driver is correctly installed in the luminaire and cabled on the power supply side
- \_ A motion sensor is installed in the lighting system
- \_ The motion sensor is connected to the LED Driver

#### Procedure:

- \_ Connect the neutral conductor (N) to terminal DA/N on the LED Driver
- \_ Connect the output of the motion sensor (switched phase) to terminal DA/L on the LED Driver

#### Wiring versions:

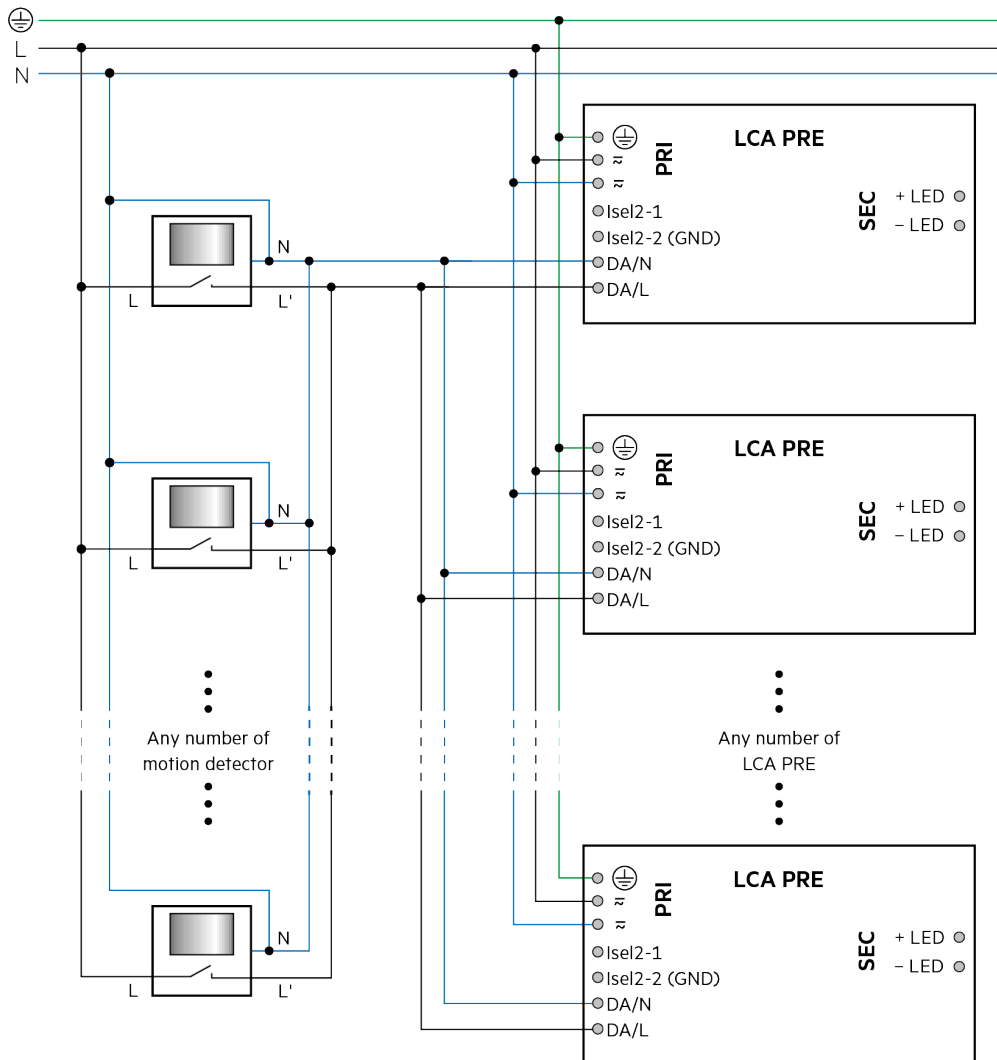

## Functions

### Benefits:

Control can be changed at any time to a digital control signal (DSI or DALI) without having to change the luminaire or provide an additional control line

#### CAUTION!

Use conventional relay motion sensors!  
Electronic motion sensors (Triac) are not suitable because of their technical design.

#### CAUTION!

Do not use glow switches!  
Glow switches may affect the control.

#### CAUTION!

Make sure that the control line (L') of the motion sensor is connected to terminal DA/L and the neutral conductor (N) to terminal DA/N.

#### CAUTION!

For five-pole wiring the neutral conductor must be connected to DA/N.  
This prevents 400 V being applied between adjacent terminals if a different phase is used for the control input.

#### NOTICE

For large installations, supply to the LED Driver may be split among several phases (L1, L2, L3).  
Any phase can be used for the control input .  
Any number of motion sensors can be connected in parallel.

## Functions

### 6.2. DSI (PRE only)

#### 6.2.1. Description

DSI (Digital Serial Interface) enables DSI control gear to be controlled. The DSI line can be wired separately via a two-core cable or together with the mains cable in a five-core cable. Communication is not impaired by the mains cable. In contrast to DALI, there is no individual addressing of the ballasts with DSI.

DSI offers a series of benefits:

- \_ Expansion options via submodules, for example in combination with daylight control or additional switch modules
- \_ Wiring: Simple wiring with five pole standard cables and line length of up to 250 metres
- \_ Wiring: Polarity-free control lines can be used for mains and control lines
- \_ Wiring: Multiple wiring possibilities (star, series and mixed wiring)
- \_ Unaffected by electrical interference: Uniform light level from the first to the last light source
- \_ reverse polarity protected connection: can be connected with any polarity

The main benefits of DSI are the optimisation of energy consumption of extensive groups of luminaires (e.g. in sports stadiums and factories).

#### 6.2.2. Commissioning

##### NOTICE

If the corridorFUNCTION is activated the LED Driver is controlled only by motion. To operate the LED Driver via DALI, DSI or switchDIM the corridorFUNCTION must be deactivated.

Further information can be found in the DALI Handbook (see [Reference list](#), S. 71).

## Functions

### 6.3. switchDIM (PRE only)

#### 6.3.1. Description

With the switchDIM function it is possible to use the mains voltage as a control signal.

The phase of a simple standard mains voltage push button is connected to the terminal marked DA/L and the neutral conductor is connected to the terminal marked DA/N.

Using the function is easy and convenient:

- \_ A short press (50-600 ms) switches the device on or off
- \_ A long press (> 600 ms) fades the connected operating device alternately up and down (between 1 and 100 %).

switchDIM is therefore a very simple form of lighting management. It also has a positive effect on material and labour costs.

The device has a switchDIM memory function. This is used, among other things, for storing the last dimming value in the event of interruptions in the power supply.

When power returns, the LED is automatically restored to its previous operating state and dimmed to the last value.

#### CAUTION!

Glow switches are not approved for controlling switchDIM.

Glow switches may cause the LED Driver to spontaneously switch on or off or make sudden changes in the dimming value.

#### CAUTION!

To ensure correct operation a sinusoidal mains voltage with a frequency of 50 Hz or 60 Hz is required at the terminal.

Special attention must be paid to achieving clear zero crossings. Serious mains faults may impair the operation of switchDIM and corridorFUNCTION.

#### CAUTIONS!

A maximum number of 25 operating devices per switchDIM system should not be exceeded.

If you have more devices please use DALI or DSI.

#### 6.3.2. Commissioning

##### NOTICE

If the corridorFUNCTION is activated the LED Driver is controlled only by motion. To operate the LED Driver via DALI, DSI or switchDIM the corridorFUNCTION must be deactivated.

#### Using the switchDIM function

switchDIM is operated by the mains voltage push button.

## Functions

Procedure:

- \_ Switch the device on/off by briefly actuating the push button or
- \_ Dim the device by holding down the push button

### Synchronising devices

If the devices in a system do not operate synchronously the devices must be synchronised, i.e. put in the same status (on/off).

Procedure:

- \_ Hold down the push button for 10 seconds
  - > All devices will be synchronised to the same status
  - > LEDs will be set to a uniform light value (approx. 50 %)
  - > The fading time will be set to its default value (approx. 3 seconds)

### Changing the fading time

The default value for the fading time is approx. 3 seconds. It can be changed to approx. 6 seconds.

Procedure:

- \_ Hold down the push button for 20 seconds
  - > After 10 seconds: all devices will be synchronised to the same status
  - > After 20 seconds: a fading time of approx. 6 seconds will be set
  - > LEDs will be set to a uniform light value (approx. 100 %)

### Switching the LED Driver to automatic mode

In automatic mode the device detects which control signal (DALI, DSI, switchDIM, etc.) is connected and automatically switches to the corresponding operating mode.

Procedure:

- \_ Press the push button 5 times within 3 seconds

## 6.3.3. Installation

### Wiring variants

There are two options for installing switchDIM: four-pole and five-pole wiring



## Functions

### Four-pole wiring

Configuration:

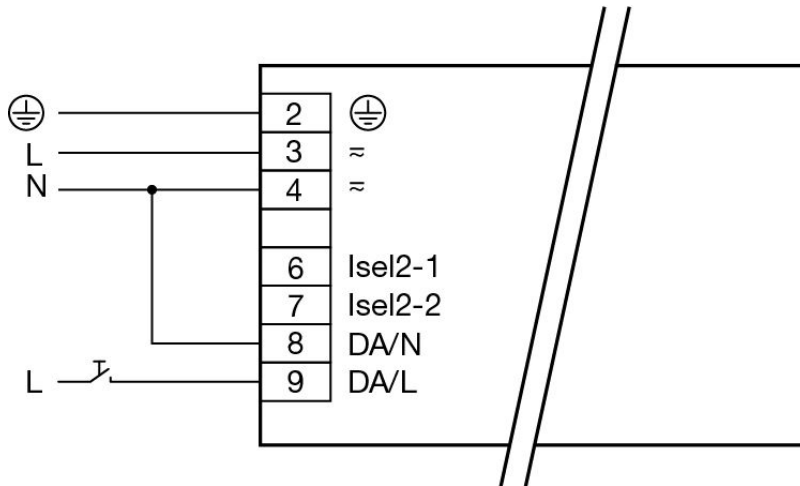

Phase (L), neutral (N), earth (PE), control line (L')

Benefits:

No need for a control line thanks to bridging terminal 8 and the N-connection of the luminaire

### Five-pole wiring

Configuration:

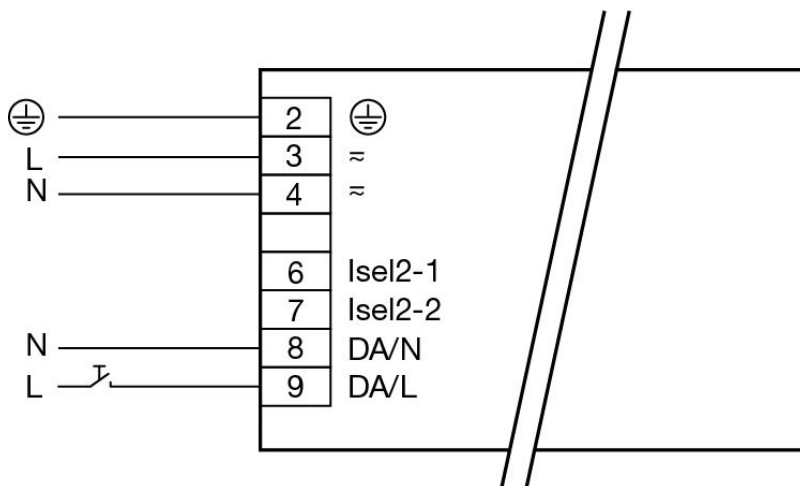

Phase (L), neutral (N), earth (PE), control line (L), neutral (N)

Benefits:

Control can be changed at any time to a digital control signal (DSI or DALI) without having to change the luminaire or provide an additional control line

## Functions

**⚠ CAUTION!**

For five-pole wiring the neutral conductor must be connected to DA/N.  
This prevents 400 V being applied between adjacent terminals if a different phase is used for the control input.

## Functions

### 6.4. Power-up Fading (PRE only)

#### 6.4.1. Description

The power-up fading function offers the opportunity to realise a soft start. The soft start will be applied at turning on the mains and at starts by switchDIM. The function is programmed as a DALI fade time in the range from 0.7 to 16 seconds and dims in the selected time from 0% to the power-on level.

By factory default power-up fading is not active (0 seconds).

#### 6.4.2. Commissioning

Procedure via the masterCONFIGURATOR

- \_ Open dialog box "Tridonic-specific configuration"
- \_ Click tab "Power-up Fading"
- \_ Choose value from drop-down menu "Power-up Fading"
- \_ Click "save"  
-> Changes are saved

Further information can be found in the masterCONFIGURATOR manual (see [Reference list](#), S. 71).

## Functions

### 6.5. DALI (PRE only)

#### 6.5.1. Description

##### DALI standard

###### **i** NOTICE

LCA PRE devices support the new DALI standard V2 (according to EN 62386-102).

DALI (Digital Addressable Lighting Interface) is an interface protocol for digital communication between electronic lighting equipment.

The DALI standard was developed by Tridonic together with renowned manufacturers of operating and control equipment. Today, these manufacturers belong to the DALI Activity Group which promotes the use and further development of DALI.

The DALI standard is defined in IEC 62386. A test procedure standardised by the DALI Activity Group ensures compatibility between products from different manufacturers. Tridonic products have undergone this test and meet all the requirements. This is indicated by the logo of the DALI Activity Group on the device.

The agreement by the lighting industry to adopt a common protocol has opened up a virtually unlimited number of options. With the right choice of individual DALI components an extremely wide range of requirements can be met, from operating a simple light switch to lighting management systems for entire office complexes with thousands of light sources.

##### DALI in Action

DALI offers a lot of possibilities:

- \_ DALI line: 64 LED Driver can be grouped to a line
- \_ DALI groups: Every LED Driver can be attributed into 16 groups
- \_ Addressability: All LED Driver are individually addressable
- \_ Grouping: Possible without complicated rewiring
- \_ Programmability: Individual programmability makes it possible to use functions which transcend the DALI standard
- \_ Monitoring: Easily possible thanks to status feedback
- \_ Wiring: Simple wiring with five pole standard cables and a cable length of max. 300 metres
- \_ Wiring: Polarity-free control lines can be used for mains and control lines
- \_ Wiring: Multiple wiring possibilities (star, series and mixed wiring)
- \_ Unaffected by interruptions: All luminaires receive the same, unaffected digital signal and dimming level
- \_ Similar light level from first to last luminaire

Technical data of a DALI line:

- \_ DALI voltage: 9.5 V - 22.4 DC
- \_ Maximum DALI system current: max. 250 mA
- \_ Data transfer rate: 1200 Baud
- \_ Maximum line length: up to 300 m (for 1,5 mm<sup>2</sup>)

## Functions

### 6.5.2. Commissioning

#### NOTICE

If the corridorFUNCTION is activated the LED Driver is controlled only by motion. To operate the LED Driver via DALI, DSI or switchDIM the corridorFUNCTION must be deactivated.

Further information can be found in the DALI Handbook (see [Reference list](#), S. 71).

#### eD

eD ("enhanced DALI") offers extended DALI commands. They can be used to activate specific commands of the LED Driver. The masterCONFIGURATOR software works with eD commands. These commands are Tridonic specific. They are not part of the DALI standard and are not publicly available.

## Functions

### 6.6. ready2mains

#### 6.6.1. Description

ready2mains uses the mains cable to transmit information: easily, reliably and professionally.

Luminaires are controlled and dimmed directly via the mains, with no need for any additional wiring. ready2mains can be used to configure both drivers with a separate communication interface as well as fixed output drivers. The configuration saves time and is very flexible. ready2mains reduces production costs and installation costs and also reduces possible sources of error.

#### 6.6.2. Dimming (PRE only)

ready2mains allows for mains-based group dimming, controlled via the ready2mains protocol and appropriate dimming interfaces. For details on the operation of ready2mains and its components see the relevant technical information.

- \_ Easy refurbishment of dimmable and non-dimmable installations
- \_ No rewiring within the ceilings
- \_ Allows cost-effective solutions

#### 6.6.3. Configuration

The ready2mains interface can be used to configure the main parameters of LED Drivers via the mains wiring (LED output current, CLO and DC level for LCA PRE; LED output current for LC EXC). These parameters can be adjusted either via ready2mains-capable configuration software or directly via the ready2mains programmer (output current only). Further information can be found in the Leaflet ready2mains (see [Reference list](#), S. 71).

- \_ Easy configuration of luminaires
- \_ Simple integration in existing test setups

## Functions

### 6.7. Constant Light Output (PRE only)

#### 6.7.1. Description

The light output of an LED module reduces over the course of its life. The Constant Light Output function compensates for this natural decline by constantly increasing the output current of the LED Driver throughout its life. As a result, a virtually uniform light output is achieved at all times.

For configuration purposes the expected module-specific values for lifetime and residual luminous flux must be specified. The output current is then controlled automatically on the basis of these values.

The LED Driver typically starts with an output current ("Required Intensity") that corresponds to the expected residual luminous flux and calculates the increase in the value on the basis of the anticipated lifetime.

If the OTL function is enabled, visual feedback is given as soon as the LED exceeds the expected LED lamp life. If the expected LED lamp life is exceeded, the luminaire flashes for 2 seconds after being switched on.

#### 6.7.2. Commissioning

##### Procedure via the masterCONFIGURATOR

###### NOTICE

To be able to adjust the parameters "Required intensity", "LED burning hours" and "Expected LED life" the "Advanced settings" must be activated.

Further information can be found in the masterCONFIGURATOR manual (see [Reference list](#), S. 71).

##### Activating the Constant Light Output function

- \_ Open dialog box "Tridonic-specific configuration"
- \_ Click tab "CLO and OTL"
- \_ Set drop-down menu "Constant intensity" to "enabled"
- \_ Click "save"
- > Changes are saved

##### Activating the Over the Lifetime function

- \_ Open dialog box "Tridonic-specific configuration"
- \_ Click tab "CLO und OTL"
- \_ Set drop-down menu "Visual feedback" to "enabled"
- \_ Click "save"
- > Changes are saved

## Functions

### Setting Required intensity and Expected LED life

- \_ Open dialog box "Tridonic-specific configuration"
- \_ Click tab "CLO and OTL"
- \_ Enter values in input fields "Required intensity" and "Expected LED life"
- \_ Click "save"  
-> Changes are saved

### Transferring existing values to a new LED Driver

If a control gear is replaced the existing parameter values can be transferred to the new LED Driver.

- \_ Chose a control gear that is in the same room as the new control gear
- \_ Open dialog box "Tridonic-specific configuration"
- \_ Click tab "CLO and OTL"
- \_ Note down the values for "Required intensity", "LED burning hours" and "Expected LED life"
- \_ Close dialog box "Tridonic-specific configuration"
- \_ Chose the new control gear
- \_ Open dialog box "Tridonic-specific configuration"
- \_ Click tab "CLO and OTL"
- \_ Take the noted values and enter them in the input fields "Required intensity", "LED burning hours" and "Expected LED life"
- \_ Click "save"  
-> Changes are saved

### Replacing the LED module

If an LED module is replaced the parameter "LED burning hours" must be set to "0".

- \_ Open dialog box "Tridonic-specific configuration"
- \_ Click tab "CLO and OTL"
- \_ Delete value from input field "LED burning hours"  
-> CLO function is automatically restarted  
-> Changes are saved

Further information can be found in the masterCONFIGURATOR manual (see [Reference list](#), S. 71).



## Functions

### 6.8. DC recognition

#### 6.8.1. Description

In emergency light systems with central battery supply the DC recognition function uses the input voltage to detect that emergency mode is in place. The LED Driver then automatically switches to DC mode and dims the light to the defined DC level. Without DC recognition different and more complex solutions need to be applied in order to detect emergency mode.

- \_ LED Driver of the LCA PRE series are factory preset to a DC level of 15 %. This value can be customised. Further information can be found in the masterCONFIGURATOR manual (see [Reference list](#), S. 71).
- \_ LED Driver of the LC EXC series have different DC levels. Further information can be found in the data sheet of the corresponding LED Driver (see [Reference list](#), S. 71).

#### NOTICE

The LED Driver is designed to operate on DC voltage and pulsing DC voltage.  
In DC recognition connected sensors are ignored.

#### 6.8.2. Commissioning

The function is integrated in the device as standard. No additional commissioning is necessary for activation.

## Functions

### 6.9. Dimming on DC (PRE only)

#### 6.9.1. Description

If Dimming on DC is activated the requirements of the DC recognition function are ignored. Even if DC is detected the LED Driver continues to behave as in AC mode:

- \_ The present dimming level is retained
- \_ An emergency light level defined for the DC recognition function (DC level) is ignored
- \_ Control signals via DALI und DSI continue to be executed

#### 6.9.2. Commissioning

##### WARNING!

If Dimming on DC is activated then emergency mode is not recognised. The device no longer automatically switches to the emergency light level.

Make sure that if Dimming on DC is activated an appropriate dimming level is selected for the emergency lighting mode.

Please also note the following:

- \_ Dimming on DC may only be activated by trained personnel
- \_ A security code must be entered before activation
- \_ The security code is issued only after a consent form has been signed
- \_ Dimming on DC must not be used in emergency lighting systems to EN 50172

#### Procedure with masterCONFIGURATOR

Further information can be found in the masterCONFIGURATOR manual (see [Reference list](#), S. 71).

## Functions

### 6.10. Intelligent Temperature Guard

#### WARNING!

The  $T_c$  temperature is the maximum permitted in terms of safety.  
 Operating the LED Drivers above the permitted  $T_c$  temperature is not compliant with relevant standards.  
 The Intelligent Temperature Guard function does not replace the proper thermal design of the luminaire and does not enable the lighting to operate for lengthy periods of time in impermissible ambient temperatures.

#### 6.10.1. Description

The Intelligent Temperature Guard function provides protection against temporary thermal overloads. It slowly reduces the output if the maximum  $T_c$  temperature is exceeded. This way instant failure of the LED Driver can be prevented. Thermal overload protection is triggered as soon as the  $T_c$  temperature is exceeded by around 5 to 10 °C. The precise trigger temperature depends on the device. The value is selected so that the protection function is not performed until there is a significant impact on rated life.

The output is reduced in small stages that are generally imperceptible to the user. The temperature is checked every two minutes.

#### 6.10.2. Behaviour

The following table shows the exact behaviour and parameters of the Intelligent Temperature Guard function for LCA PRE and LC EXC

| Parameters                          | Description                                                                                                                                                                                                                                                                                                                                                                                                                                                                                                                                                                                                                                          |
|-------------------------------------|------------------------------------------------------------------------------------------------------------------------------------------------------------------------------------------------------------------------------------------------------------------------------------------------------------------------------------------------------------------------------------------------------------------------------------------------------------------------------------------------------------------------------------------------------------------------------------------------------------------------------------------------------|
| Start of power reduction            | When maximum operating temperature ( $T_c$ ) is exceeded by approx. 5-10 °C <sup>(1)</sup>                                                                                                                                                                                                                                                                                                                                                                                                                                                                                                                                                           |
| Power reduction rate                | Reduction of max level by 1 dim step / 2 min                                                                                                                                                                                                                                                                                                                                                                                                                                                                                                                                                                                                         |
| Power reduction process and control | <p>Power reduction is dependent on temperature:</p> <ul style="list-style-type: none"> <li>_ Power reduction continues if temperature still rises</li> <li>_ Power reduction stops if temperature does not rise anymore or if maximum power reduction is reached (minimum power level = 50 %)</li> <li>_ If temperature falls below a certain level, power is increased again until 100 % is reached</li> <li>_ If temperature still rises even if maximum power reduction is reached:               <ul style="list-style-type: none"> <li>_ PRE drivers go to 15 % dim level</li> <li>_ EXC drivers go to minimum dim level</li> </ul> </li> </ul> |
| Min power level                     | ca. 50 % dim level <sup>(2)</sup>                                                                                                                                                                                                                                                                                                                                                                                                                                                                                                                                                                                                                    |
| Shut off behaviour                  | <p>No shut off behaviour:<br/>         Device will not shut off if temperature still rises.</p> <ul style="list-style-type: none"> <li>_ AC mode: Device switches to 15 % dimming level for PRE and to minimum dim level for EXC</li> <li>_ DC mode: Intelligent Temperature Guard is not relevant because driver goes to EOFx level anyway</li> </ul>                                                                                                                                                                                                                                                                                               |

## Functions

|                             |                                                                         |
|-----------------------------|-------------------------------------------------------------------------|
| Automatic restart behaviour | No automatic restart behaviour (because there is no shut off behaviour) |
| Restart temperature         | No restart temperature                                                  |

- <sup>(1)</sup> Rated  $T_c$  is device specific.  
<sup>(2)</sup> The lowest possible dim level of EXC drivers depends on the connected load.

### **i** NOTICE

The standard setting for the dimming curve is logarithmic:  
 If alternative dimming curves are used the power reduction can be implemented differently.

### 6.10.3. Adjusting the Offset

Here you can configure the Intelligent Temperature Guard (ITG). ITG is intended to protect the device from thermal damage. The device uses four predefined parameters: start reduction, stop reduction, critical temperature, restart temperature.

This value can be programmed on a compatible device with masterCONFIGURATOR version V 2.30.0.70.

The Offset parameter reduces these four parameters by the selected value. The maximum allowed offset is shown in a own tab.

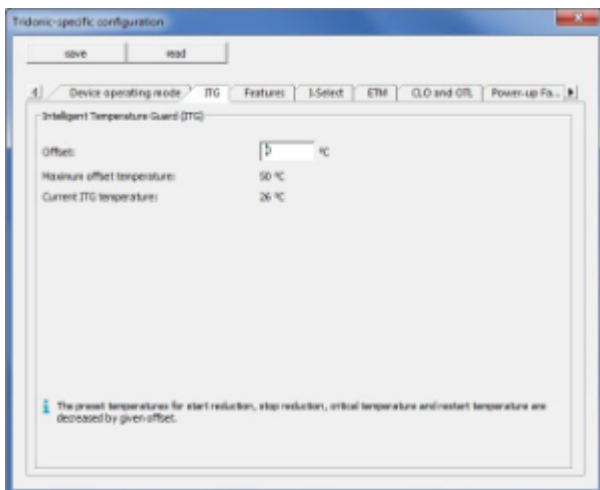

## Functions

### 6.11. colourSWITCH

#### 6.11.1. Description

A conventional pushbutton can be used to control the system via colourSWITCH.  
Using a push button with indicator lamp is not permitted.

#### **i** NOTICE

If the device is controlled via DALI/DSI, colourSWITCH is not available.

#### 6.11.2. colourSWITCH use cases

- The tuneable white driver and LED modules from Tridonic as a calibrated bundle
- The tuneable white driver and LED modules from Tridonic separately

For control via a push button different settings can be made:

- Short press: Setting the colour temperature via colourSWITCH mode with 9 predefined scenes between 2,700 and 6,500 K.
- Long press (> 1 s): Stepless setting of colour temperature.  
After completion the colour temperature direction will be inverted.
- These values can be changed via masterCONFIGURATOR.

#### Synchronization

In installations with LED Drivers with different colour temperatures or opposite colour temperature directions (e.g. after a system extension), all LED Drivers can be synchronized to 4,500 K by pressing the button for 10 seconds.

#### Predefined Scenes

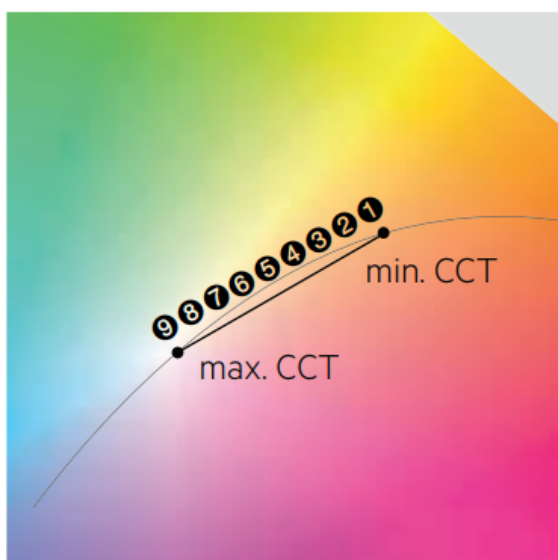

## Functions

### Wiring diagram

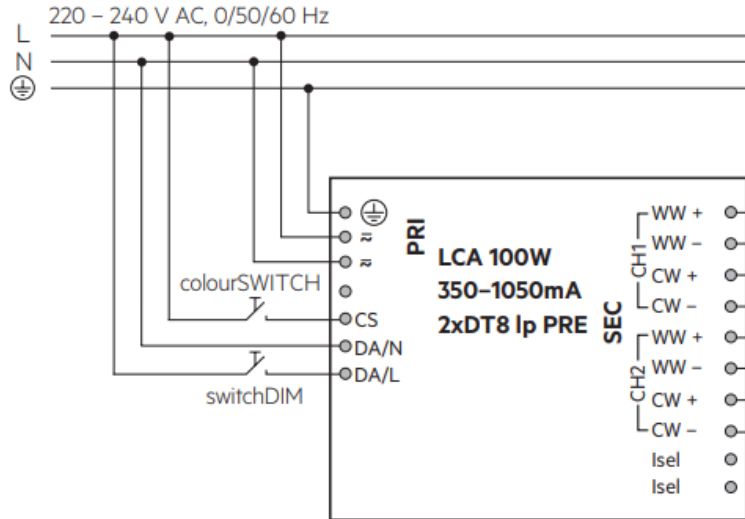

### Short press behaviour

A short press provides the user the possibility to switch between different CCT (correlated color temperature) values, which are stored as special scenes.

- \_ At each short press the next CCT value (= next scene) shall be set without fading.
- \_ If the last CCT value (= last scene) is reached the next short press shall continue with the first CCT value (= first scene)
- \_ CCT values = MASK shall be skipped - the next Non-MASK value shall be set (could be also the first scene)

#### **i** NOTICE

The default starting CCT value shall be the 4<sup>th</sup> CCT value (= scene 4) in the list (per default 4,000 K).

If at least one long press is in between two short presses, the next short press shall recall the current CCT value instead of continuing with the next CCT value.

There shall be no reaction on short press if the gear is in standby mode (lamp is off).

### Long press behaviour

At a long press, the gear shall fade the CCT using the actual colourSWITCH fade rate. The intensity shall not be changed due to a long press.

- \_ default direction is from warm (default = 2,700 K) to cool (default = 6,500 K)
- \_ each long press the direction of colour fading shall toggles
- \_ after sync press the fade direction shall be always the default direction
- \_ no reaction on long press if the gear is in standby mode (lamp is off)

## Functions

### Sync press behaviour

At any sync press of switchDIM or colourSWITCH, the gear will be set to default again on both functions!

- \_ The CCT value shall be set according to the 4<sup>th</sup> CCT value (= scene 4)
- \_ The direction of CCT fading for the next long press is set from warm to cool
- \_ The colourSWITCH fade rate shall be set to default
- \_ switchDIM is set to default (according sync press specification of switchDIM)
- \_ The colourSWITCH fading time will be set to default (2.5 s)
- \_ switchDIM is set to default (according to sync press specification of switchDIM)

### Fade press behaviour

At any fade press (longer than 20 seconds) of switchDIM or colourSWITCH the colourSWITCH fading time will be set to 5 seconds. Likewise the fade press and also a sync press shall be applied to both switchDIM and colourSWITCH.

### Memory Colour Value

Once the device is in colourSWITCH mode the current CCT value and the currently selected scene number shall be stored at power-down. These settings shall be recalled at the next power-on. For the very first power-on (no Memory CCT) the default settings shall be applied.

### Configuration and default settings

| colourSWITCH fade rate | Definition                                                                 |
|------------------------|----------------------------------------------------------------------------|
| default                | ca. 2,5s from 2700K to 6500K and vice versa, longer if CCT range is bigger |
| slow                   | ca. 5s from 2700K to 6500K and vice versa, longer if CCT range is bigger   |

| Scene no.   | CCT value          | Scene no. | CCT value          |
|-------------|--------------------|-----------|--------------------|
| 1           | 0x0A8C (= 2,700 K) | 6         | 0x1388 (= 5,000 K) |
| 2           | 0x0BB8 (= 3,000 K) | 7         | 0x157C (= 5,500 K) |
| 3           | 0x0DAC (= 3,500 K) | 8         | 0x1770 (= 6,000 K) |
| 4 (default) | 0x0FA0 (= 4,000 K) | 9         | 0x1964 (= 6,500 K) |
| 5           | 0x1194 (= 4,500 K) | 10        | 0xFFFF (MASK)      |

### 6.11.3. colourSWITCH mode

colourSWITCH is not a separate one4all mode but a functional extension to switchDIM mode.

This means:

## Functions

- \_ colourSWITCH is only functional if switchDIM mode is active (so colourSWITCH is not functional in cF mode)
- \_ A colourSWITCH press may activate switchDIM mode in automatic one4all mode (if one4all conditions are met)
- \_ colourSWITCH and switchDIM can be used in parallel
- \_ In corridorFUNCTION mode the default colour of colourSWITCH shall be applied (= scene 4, 4,000 K).

### Miscellaneous

- \_ Lamp errors shall be ignored by colourSWITCH
- \_ At start-up always the default CCT direction (from warm to cool) is applied

### Colour Temperature Range

The range in which the colour temperature of the LED module can be changed can be set here. The colour temperature range is restricted to the physical upper and lower limits.

- \_ Minimum colour temperature: the warmest colour temperature that a lamp can have. This temperature is either the physical lower limit or is cooler than this limit.
- \_ Maximum colour temperature: the coolest colour temperature that a lamp can have. This temperature is either the physical upper limit or is warmer than this limit.
- \_ Physical lower limit: Allows the LED driver to be adjusted to the colour temperature limits of the connected LED module.
- \_ Physical upper limit: Allows the LED driver to be adjusted to the colour temperature limits of the connected LED module.

This range can be programmed via masterCONFIGURATOR V 2.30.0.70 or newer.

The screenshot displays the TRIDONIC masterCONFIGURATOR V 2.30.0.70 interface. At the top, there are buttons for 'read', 'save', 'Quick test', '0', 'readdress', and 'Factory settings'. The 'TRIDONIC' logo is on the right. Below this is the 'Device information' section, which includes the name 'LCA 100W 350-1050mA 2xDT8 lp PRE K' and various technical specifications: Date of manufacture (04/09/2017), Firmware version (V0.11), DALI version (V2.0), eD version (V1.4), Article number (28002095), Serial number (0000852316.001331), and Light source (LED). The main configuration area is titled 'Colour temperature range' and contains four sliders: 'Physical lower limit' (set to 2700 K), 'Minimum colour temperature' (set to 2700 K), 'Maximum colour temperature' (set to 6500 K), and 'Physical upper limit' (set to 6500 K). Navigation tabs at the bottom include 'Basic configuration', 'Colour', 'LED', 'Status LED', 'Status Colour', 'Overview LED', and 'Overview Colour'.



## Functions

### 6.12. proportionSWITCH (PRE only)

#### 6.12.1. Description

A conventional push button can be used to control the system via proportionSWITCH. Using a of push button with indicator lamp is not permitted.

#### NOTICE

If the device is controlled via DALI/DSI, proportionSWITCH is not available.

#### 6.12.2. proportionSWITCH use cases

- \_ For proportionSWITCH use cases a tuneable white device and the use of colourSWITCH is proposed. Theoretically it is also possible with static white driver and proportionSWITCH as well but the colour and dim performance is very limited
- \_ Static driver with DT6 and possibility to individually dim direct and indirect light

For control via pushbutton, different settings can be made:

- \_ Short press:
  - Setting of 5 pre-defined light levels (variable for each channel for direct and indirect applications).
  - A maximum of 10 scenes can be programmed.
- \_ Long press (> 1 s):
  - Stepless setting of dimming level. Both channels running in opposite direction
  - After completion, the dimming direction of both channels will be inverted.
  - Values can be changed via masterCONFIGURATOR.

In installations with LED Drivers with different dimming level or opposite dimming direction (e.g. after a system extension), all LED Drivers can be synchronized to a standard value by a 10 seconds push.

## Functions

### Wiring diagram

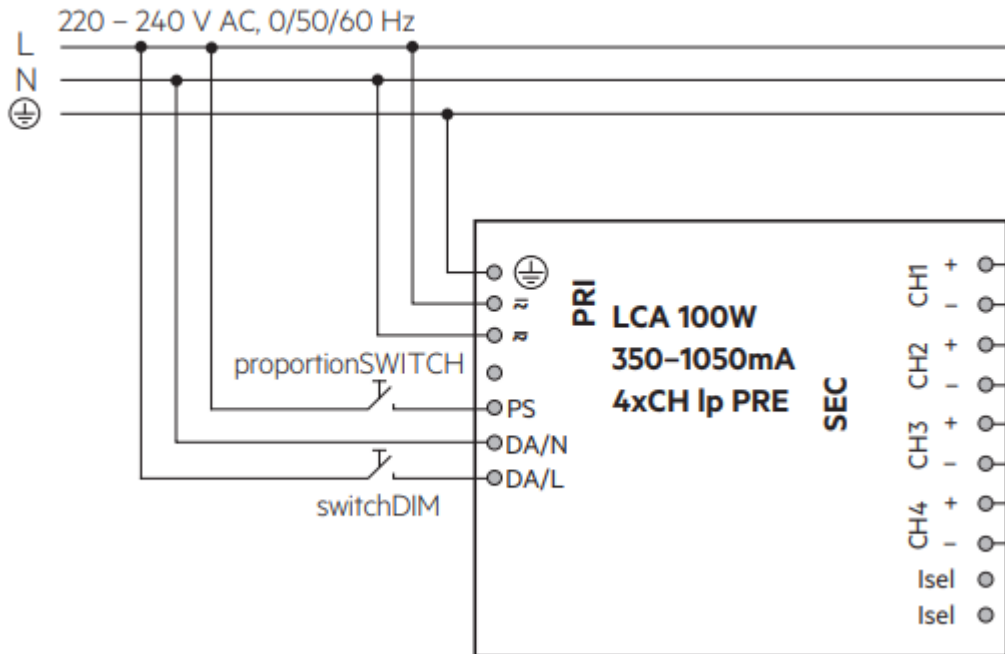

### Short press behaviour

A short press provides the user the possibility to switch between different dim levels per channel (= ratio per pair).

- \_ With each short press the next level shall be set without fading
- \_ If the last level is reached, the next short press shall continue with the first level
- \_ The default starting level shall be the third level in the row (per default 50 % / 50 %)

Since the two channels of a pair shall not be independent, the following applies for dim level = MASK:

- \_ One channel: "no change" (e.g. 50 % / MASK)
- \_ Both channels: MASK means "skip" (e.g. MASK / MASK).  
In this case the next valid value shall be set (this could be also the first level).

If at least one long press or any switchDIM press is in between two short presses, the next short press shall recall the current level instead of continuing with the next level.

#### **i** NOTICE

Short press works similar to a DALI Goto Scene command for each channel.

If the gear is in standby mode, lamps might be switched on with a short press.

## Functions

### Long press behaviour

- \_ With a long press, the gear shall fade both channels up or down
- \_ opposite direction using the actual switchDIM fade rate
- \_ The direction of fading of each channel will toggle
- \_ The default direction shall be upwards for 4 channel device channel 1 + 3 (= logical unit 1) and downwards for channel 2 + 4 (= logical unit 2)
- \_ With a sync press the fade direction shall be always the default direction

If the gear is in standby mode, lamps shall be switched on with a long press using the default direction; this means: channel 1 and 3 (on 4 channel devices) dims up to 100% and channel 2 and 4 (on 4 channel devices) stays at Physical Minimum Level (PHM)

- \_ Once one channel reaches its physical minimum or maximum level at a long press the corresponding channel stops dimming.
- \_ The other channel will continue dimming if the minimum or maximum isn't reached at the same time

### Sync press behaviour:

- \_ With a sync press of switchDIM or proportionSWITCH, the gear shall be set to default again
- \_ The dim level (ratio) setting shall be set to the third level for the next short press
- \_ The dimming fade rate is set to default (2.5 seconds)
- \_ The direction of dim level fading for the next long press shall be upwards for channel 1 + 3 (on 4 channel devices) and downwards for channel 2 + 4 (on 4 channel devices)
- \_ switchDIM fade rate shall be set to default
- \_ The dim level after a sync press is 50 % for both channels, according to the switchDIM specification
- \_ A sync press of proportionSWITCH shall synchronise switchDIM as well switchDIM.

### Fade press behaviour

At any fade press of switchDIM or proportionSWITCH the switchDIM fading time shall be set to fast (5 seconds). Likewise the fade press and also a sync press shall be applied to both switchDIM and proportionSWITCH.

### Memory level

Once the device is in proportionSWITCH mode, the current dim level and the currently selected ratio shall be stored at power-down. These settings shall be recalled at the next power-on.

For the very first power-on (no memory dim level), the default settings shall be applied.

## Functions

### Configuration and default settings

| switchDIM fade rate | Definition                                                                  |
|---------------------|-----------------------------------------------------------------------------|
| default             | 2 DSI steps per mains period (= ca. 2.5 s from 1 % to 100 % and vice versa) |
| slow                | 1 DSI steps per mains period (= ca. 5 s from 1 % to 100 % and vice versa)   |

| Level no.   | Level CH1   | Level CH2   | Level no. | Level CH1  | Level CH2  |
|-------------|-------------|-------------|-----------|------------|------------|
| 1           | 254 (100 %) | PHM*        | 6         | 255 (MASK) | 255 (MASK) |
| 2           | 241 (70 %)  | 210 (30 %)  | 7         | 255 (MASK) | 255 (MASK) |
| 3 (default) | 229 (50 %)  | 229 (50 %)  | 8         | 255 (MASK) | 255 (MASK) |
| 4           | 210 (30 %)  | 241 (70 %)  | 9         | 255 (MASK) | 255 (MASK) |
| 5           | PHM*        | 254 (100 %) | 10        | 255 (MASK) | 255 (MASK) |

\* PHM (physical minimum level)

### 6.12.3. proportionSWITCH Mode

proportionSWITCH is not a separate one4all mode, but a functional extension to switchDIM mode.

This means:

- \_ proportionSWITCH is only functional if switchDIM mode is active (so proportionSWITCH is not functional in corridor mode)
- \_ A proportionSWITCH press may activate switchDIM mode in automatic one4all mode (if one4all conditions are met)
- \_ If proportionSWITCH and switchDIM are pressed in parallel switchDIM has priority (proportionSWITCH not functional)

### 6.12.4. proportionSWITCH programming

The scenes for proportionSWITCH can be programmed via masterCONFIGURATOR.

## Functions

◀ CLO and OTL Power-up Fading proportionSWITCH Current consumption General log ▶

proportionSWITCH scenes

|                                     |          |             |
|-------------------------------------|----------|-------------|
| <input checked="" type="checkbox"/> | Scene 1  | 100 % [254] |
| <input checked="" type="checkbox"/> | Scene 2  | 70 % [241]  |
| <input checked="" type="checkbox"/> | Scene 3  | 51 % [229]  |
| <input checked="" type="checkbox"/> | Scene 4  | 30 % [210]  |
| <input checked="" type="checkbox"/> | Scene 5  | 1.0 % [86]  |
| <input type="checkbox"/>            | Scene 6  | MASK [255]  |
| <input type="checkbox"/>            | Scene 7  | MASK [255]  |
| <input type="checkbox"/>            | Scene 8  | MASK [255]  |
| <input type="checkbox"/>            | Scene 9  | MASK [255]  |
| <input type="checkbox"/>            | Scene 10 | MASK [255]  |

**i** These values can be selected by the PS input  
The input values are limited by the physical minimum level

## Functions

### 6.13. 1-10 V Interface

#### 6.13.1. Description

LED Driver of the LC EXC series have a 1-10 V interface which allows the connection of an analogue 1-10 V dimmer. With this, the output current can be further reduced. As a result the light level is also reduced.

The minimum achievable light level depends on the operating point of the connected LED module and can thereby vary.

#### 6.13.2. Wiring diagram

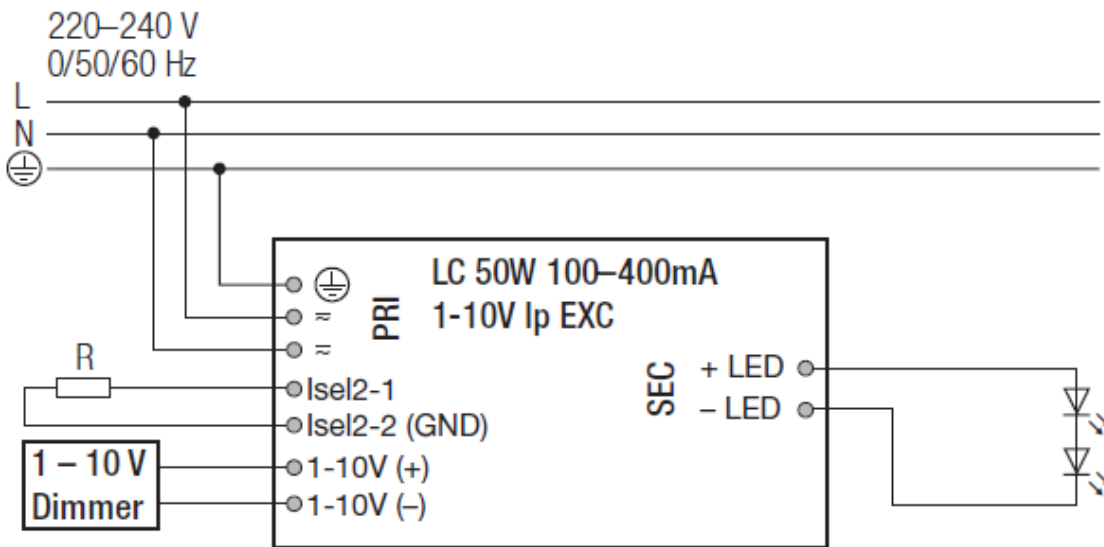

#### 6.13.3. Control input (1-10 V)

| Parameter                     | Value              |
|-------------------------------|--------------------|
| Control input open            | max. dimming level |
| Control input short-circuited | min. dimming level |
| Output current range          | 400 – 500 $\mu$ A  |
| Max. permitted input voltage  | $\pm$ 16 V         |
| Voltage range dimming         | 1 – 10 V           |
| Input voltage < 1 V           | min. dimming level |
| Input voltage > 10 V          | max. dimming level |

## Reference list

### 7.1. Additional information

- \_ Web page premium series (Compact dimming):  
<http://www.tridonic.com/com/en/products/led-drivers-compact-dimming-premium.asp>
- \_ Web page excite series (Compact fixed output):  
<http://www.tridonic.com/com/en/products/led-drivers-compact-fixed-output-excite.asp>
- \_ Data sheets: Go to above web page link and click "Products" > "Downloads" > "Data sheet"
- \_ Accessories: Go to above web page link and click "Products" > "Downloads" > "Accessories"
- \_ DALI manual: [http://www.tridonic.com/com/en/download/technical/DALI-manual\\_en.pdf](http://www.tridonic.com/com/en/download/technical/DALI-manual_en.pdf)
- \_ Documentation masterCONFIGURATOR:  
[http://www.tridonic.com/com/en/download/Manual\\_masterConfigurator\\_en.pdf](http://www.tridonic.com/com/en/download/Manual_masterConfigurator_en.pdf)
- \_ Leaflet ready2mains:  
[http://www.tridonic.com/com/en/download/brochures/Leaflet\\_ready2mains\\_EN\\_web.pdf](http://www.tridonic.com/com/en/download/brochures/Leaflet_ready2mains_EN_web.pdf)
- \_ Web page corridorFUNCTION: <http://www.corridorfunction.com/corridorFUNCTION/index.html>

### 7.2. Downloads

- \_ Tridonic software: <http://www.tridonic.com/com/en/software.asp>
- \_ Download masterCONFIGURATOR: <http://www.tridonic.com/com/de/software-masterconfigurator.asp>

### 7.3. Technical data

- \_ Data sheets: <http://www.tridonic.com/com/en/data-sheets.asp>
- \_ Company certificates: <http://www.tridonic.com/com/en/company-certificates.asp>
- \_ Environmental declarations: <http://www.tridonic.com/com/en/environmental-declarations.asp>
- \_ LED/lamp matrix: <http://www.tridonic.com/com/en/lamp-matrix.asp>
- \_ Operating instructions: <http://www.tridonic.com/com/en/operating-instructions.asp>
- \_ Other technical documents: <http://www.tridonic.com/com/en/technical-docs.asp>
- \_ Tender text: <http://www.tridonic.com/com/en/tender.asp>
- \_ Declarations of conformity: Available documents are found on each product page of our website in the "Certificates" tab for the specific product, [www.tridonic.com/com/en/products.asp](http://www.tridonic.com/com/en/products.asp)